

San Bernardino County

*Road Planning
and
Design Standards*

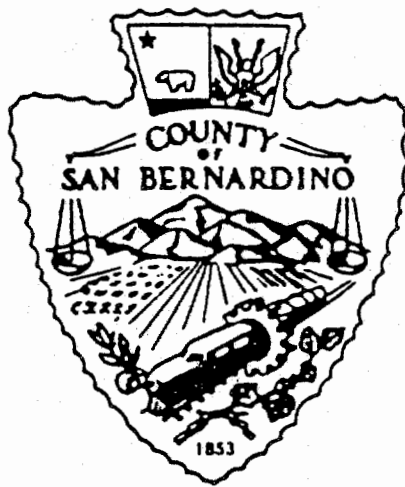

Environmental Management Group
Land Development Engineering Division
and
Public Works Group
Transportation/Flood Control
Department

SURVEYOR DEPARTMENT

3 North Arrowhead Avenue • San Bernardino, CA 92415-0183 • (909) 387-4038



COUNTY OF SAN BERNARDINO
ENVIRONMENTAL
MANAGEMENT GROUP

LARRY E. COTTON, L.S.
County Surveyor

Land Development Engineering Division

Geographic Information Management
System Division (GIMS)

April 20, 1993

To: Road Planning and Design Standards Manual Owners

Subj: Road Planning and Design Standards Manual

The Board of Supervisors adopted the Road Planning and Design Standards Manual on April 12, 1993. Attached are the replacement sheets to update your manual. Please remove Sheet 5-3. If you have any questions, please call Cy Zermeno at (909) 387-4046.

Sincerely,

LARRY J. FAST, Land Development Engineer
EMG/Surveyor Department/Land Development Engineering Division

mf

WALTER H. HAYS
County Administrator
JESSE S. WEBB
County Administrative Officer
Geography Management Group

Board of Supervisors
MARSHA TURCOI First District BARBARA CRAM BIRDAR Third District
JON D. MIKELS Second District LARRY WALKER Fourth District
JERRY EAVES Fifth District

BOARD OF SUPERVISORS

Adopted April 12, 1993

Marsha Turoci
First District

Jon D. Mikels
Second District

Barbara Cram-Riordan
Third District

Larry Walker
Fourth District

Jerry Eaves
Fifth District

ENVIRONMENTAL MANAGEMENT GROUP

Albert R. Reid, Assistant Administrative Officer

Larry J. Fast, Land Development Engineer

PUBLIC WORKS GROUP

Michael G. Walker, Assistant Administrative Officer

Ken A. Miller, Director of Transportation/Flood Control

ROAD PLANNING AND DESIGN STANDARDS SUBCOMMITTEE

Joseph P. Colley (Retired)	Land Development Engineering	Division
Silvestre (Cy) Zermeño	Land Development Engineering	Division
Augustine MacGrath (Retired)	Land Development Engineering	Division

John Steger	Transportation/Flood Control	District
Anthony Gray	Transportation/Flood Control	District
Louis Gamache (Retired)	Transportation/Flood Control	District
Ted Golondzinier	Transportation/Flood Control	District
Vana Olson	Transportation/Flood Control	District
Gary Kuhlman	Transportation/Flood Control	District
Laddie Svarc	Transportation/Flood Control	District

ADDITIONAL SUPPORT

Alfred Goer	Land Development Engineering	Division
Ruben Ibarra	Land Development Engineering	Division
Mary Flaherty	Land Development Engineering	Division

TABLE OF CONTENTS

	TITLE	PAGE
ARTICLE I INTRODUCTION		
SECTION 1.1	INTRODUCTION	1-1
1.2	PURPOSE	1-1
1.3	EXCEPTIONS	1-1
1.4	JOINTLY FINANCED PROJECTS	1-2
1.5	STAGE CONSTRUCTION	1-2
ARTICLE II DEFINITIONS AND GENERAL POLICY		
SECTION 2.1	DEFINITIONS	2-1
2.2	PLAN APPROVAL	2-2
2.3	STANDARD INTERPRETATION	2-2
2.4	PAYMENT OF IMPROVEMENTS	2-3
2.5	SUBDIVISION DEVELOPMENT	2-3
2.6	ROAD ACCESS	2-3
2.7	WIDENING EXISTING IMPROVEMENTS	2-3
2.8	DESIGN OF STREET SYSTEMS	2-3
2.9	UTILITY INSTALLATION	2-4
ARTICLE III DESIGNATION OF STREETS		
SECTION 3.1	PURPOSE	3-1
3.2	MAJOR ARTERIAL	3-1
3.3	MAJOR DIVIDED HIGHWAY	3-1
3.4	MAJOR HIGHWAY/MOUNTAIN EXPRESSWAY	3-1
3.5	SECONDARY HIGHWAY/MOUNTAIN MAJOR	3-1
3.6	CONTROLLED LIMITED/ACCESS COLLECTOR	3-2
3.7	COLLECTOR STREET	3-2
3.8	INDUSTRIAL LOCAL	3-2
3.9	MOUNTAIN SECONDARY	3-2
3.10	LOCAL STREET	3-3
3.11	LOCAL STREET (LESS THAN 500 ADT)	3-3
3.12	MOUNTAIN LOCAL	3-3
3.13	HALF-WIDTH STREET	3-3
3.14	FRONTAGE ROAD	3-3
3.15	ALLEY	3-3

	TITLE	PAGE
ARTICLE IV IMPROVEMENT LEVELS		
SECTION 4.1	DEFINITION	4-1
4.2	APPLICATION OF IMPROVEMENT LEVELS	4-2
	EXCEPTIONS	4-3
4.3	IMPROVEMENT STANDARDS - VALLEY	4-4
4.4	IMPROVEMENT STANDARDS - MOUNTAIN	4-5
4.5	IMPROVEMENT STANDARDS - DESERT	4-6
ARTICLE V STREET STANDARDS		
SECTION 5.1	CURB AND GUTTER	5-1
5.2	SIDEWALKS	5-1
5.3	DRIVEWAYS	5-1
5.4	STREET NAME SIGNS	5-2
5.5	TRAFFIC SIGNS	5-2
5.6	SURVEY MONUMENTS	5-2
5.7	MINIMUM STANDARDS	5-2
ARTICLE VI ACCESS		
SECTION 6.1	ACCESS LOCATION	6-1
6.2	CHANGE OF USE	6-1
6.3	NUMBER OF ACCESS POINTS	6-2
6.4	ACCESS SPACING	6-2
6.5	MINIMUM ACCESS SPACING TABLE	6-3
6.6	RESIDENTIAL DRIVEWAY	6-4
6.7	COMMERCIAL DRIVEWAY	6-4
6.8	VEHICLE QUEUE REQUIREMENTS	6-4
6.9	CRITERIA FOR REQUIRING SPEED CHANGE LANES	6-8
ARTICLE VII DESIGN GUIDELINES		
SECTION 7.1	VALLEY DESIGN GUIDELINES	7-1
7.2	DESERT DESIGN GUIDELINES	7-2
7.3	MOUNTAIN DESIGN GUIDELINES	7-3
ARTICLE VIII GEOMETRIC DESIGN STANDARDS		
SECTION 8.1	INTERSECTION OBJECTIVES	8-1
8.2	CAPACITY ANALYSIS	8-1
8.3	INTERSECTION ALIGNMENT	8-1
8.4	CLEAR SIGHT TRIANGLE	8-1
8.5	STOPPING SIGHT DISTANCE	8-2
8.6	INTERSECTION SIGHT DISTANCE	8-2
8.7	CHANNELIZATION	8-6
8.8	HORIZONTAL CONTROL CRITERION	8-15
8.9	STREET GRADIENT	8-18
8.10	VERTICAL CURVES	8-19
8.11	CURB RETURN DESIGN	8-24

	TITLE	PAGE
ARTICLE IV IMPROVEMENT LEVELS		
SECTION 4.1	DEFINITION	4-1
4.2	APPLICATION OF IMPROVEMENT LEVELS EXCEPTIONS	4-2 4-3
4.3	IMPROVEMENT STANDARDS - VALLEY	4-4
4.4	IMPROVEMENT STANDARDS - MOUNTAIN	4-5
4.5	IMPROVEMENT STANDARDS - DESERT	4-6
ARTICLE V STREET STANDARDS		
SECTION 5.1	CURB AND GUTTER	5-1
5.2	SIDEWALKS	5-1
5.3	DRIVEWAYS	5-1
5.4	STREET NAME SIGNS	5-2
5.5	TRAFFIC SIGNS	5-2
5.6	SURVEY MONUMENTS	5-2
5.7	MINIMUM STANDARDS	5-3
ARTICLE VI ACCESS		
SECTION 6.1	ACCESS LOCATION	6-1
6.2	CHANGE OF USE	6-1
6.3	NUMBER OF ACCESS POINTS	6-2
6.4	ACCESS SPACING	6-2
6.5	MINIMUM ACCESS SPACING TABLE	6-3
6.6	RESIDENTIAL DRIVEWAY	6-4
6.7	COMMERCIAL DRIVEWAY	6-4
6.8	VEHICLE QUEUE REQUIREMENTS	6-4
6.9	CRITERIA FOR REQUIRING SPEED CHANGE LANES	6-8
ARTICLE VII DESIGN GUIDELINES		
SECTION 7.1	VALLEY DESIGN GUIDELINES	7-1
7.2	DESERT DESIGN GUIDELINES	7-2
7.3	MOUNTAIN DESIGN GUIDELINES	7-3
ARTICLE VIII GEOMETRIC DESIGN STANDARDS		
SECTION 8.1	INTERSECTION OBJECTIVES	8-1
8.2	CAPACITY ANALYSIS	8-1
8.3	INTERSECTION ALIGNMENT	8-1
8.4	CLEAR SIGHT TRIANGLE	8-1
8.5	STOPPING SIGHT DISTANCE	8-2
8.6	INTERSECTION SIGHT DISTANCE	8-2
8.7	CHANNELIZATION	8-6
8.8	HORIZONTAL CONTROL CRITERION	8-15
8.9	STREET GRADIENT	8-18
8.10	VERTICAL CURVES	8-19
8.11	CURB RETURN DESIGN	8-24

	TITLE	PAGE
ARTICLE IX STRUCTURAL SECTION DESIGN		
SECTION	9.1 TRAFFIC INDEX	9-1
	9.2 STRUCTURAL SECTIONS	9-2
ARTICLE X TRAFFIC STUDIES		
SECTION	10.1 TRAFFIC CONGESTION	10-1
	10.2 RESPONSIBILITIES FOR TRAFFIC STUDIES	10-1
	10.3 TRAFFIC STUDY FORMAT	10-1
	10.4 INTRODUCTION	10-2
	10.5 PROJECT TRIP GENERATION & DESIGN HOUR VOLUMES	10-3
	10.6 TRIP DISTRIBUTION	10-3
	10.7 TRIP ASSIGNMENT	10-4
	10.8 EXISTING & PROJECTED TRAFFIC VOLUMES	10-4
	10.9 CAPACITY ANALYSIS	10-5
	10.10 TRAFFIC SIGNALS	10-5
	10.11 TRAFFIC ACCIDENTS	10-6
	10.12 RECOMMENDATIONS	10-6
	10.13 REVISIONS TO TRAFFIC STUDY	10-8
	10.14 EXECUTIVE SUMMARY	10-8
	10.15 TECHNICAL REQUIREMENTS OF FINAL REPORT	10-8
	10.16 DELIVERABLES	10-9
	10.17 TRAFFIC STUDY REPORT OUTLINE	10-9
ARTICLE XI TRANSPORTATION FACILITIES FEE PLANS		
SECTION	11.1 INTRODUCTION	11-1
	11.2 INTENT	11-1
	11.3 ESTABLISHMENT OF LOCAL AREA TRANSPORTATION FACILITIES PLANS	11-1
	11.4 FEE PAYMENT	11-2
	11.5 FUNDS	11-2
	11.6 FEE CALCULATION	11-3
	11.7 AGREEMENTS BETWEEN THE COUNTY AND A DEVELOPER	11-3
	11.8 EXCLUSIONS	11-3
	11.9 MISCELLANEOUS PROVISIONS	11-5
ARTICLE XII PRIVATE ROAD STANDARDS		
	12.1 PRIVATE ROAD STANDARDS	12-1
	12.2 PRIVATE DEVELOPMENTS	12-1
	12.3 PRIVATE RESIDENTIAL DEVELOPMENTS	12-3
	12.4 COMMERCIAL DEVELOPMENTS	12-4
	12.5 MOBILE HOME PARKS	12-6
	12.6 RECREATIONAL VEHICLE PARKS	12-7

ARTICLE I
INTRODUCTION

SAN BERNARDINO COUNTY TRANSPORTATION DEPARTMENT
ROAD PLANNING AND DESIGN STANDARDS

ARTICLE I

INTRODUCTION

SECTION 1.1 INTRODUCTION

Proper road design standards are necessary to provide for orderly development with minimum costs and operating expenditures. Failure to achieve minimum standards creates deficiencies which result in high user costs and are often very expensive to correct. Deficiencies can be reduced to a minimum through acquisition of rights-of-way on ultimate alignment which are capable of providing safe and reliable vehicular and pedestrian ways.

These standards are intended to provide reasonable guidelines to achieve these desired objectives.

SECTION 1.2 PURPOSE

These standards apply to and regulate all road and drainage improvements to be dedicated to the public and accepted by the County. In accordance with the General Plan directive, these standards are intended to provide for adequate, coordinated, modern development of the required facilities to serve and protect the potential uses and users of the various areas of the County of San Bernardino.

SECTION 1.3 EXCEPTIONS

It is recognized that it is not humanly possible to anticipate all situations that may arise and to prescribe standards applicable to every situation. It is anticipated that the standards will be applicable to the vast majority of cases, but they are not inflexible rules to which there are no exception. The Director of Transportation Department may make exceptions where the application of the standards to a specific situation results in unusual and unreasonable hardship, and it is not detrimental to the public interest that an exception be made.

SECTION 1.4 JOINTLY FINANCED PROJECTS

It is recognized that projects financed with State or Federal funds are subject to the standards prescribed by those agencies, and that such standards, which must be conformed to in order to qualify for these funds, may be more stringent than those prescribed herein.

SECTION 1.5 STAGE CONSTRUCTION

It is also recognized that the County has a continuing responsibility for the maintained system which differs from that of the land developer, whose responsibility ends with construction of approved facilities which should come into the system without deficiency. Therefore, stage construction may be an appropriate technique for use by the County, but its use is not feasible for private development.

ARTICLE II
DEFINITIONS AND GENERAL POLICY

ARTICLE II

DEFINITIONS AND GENERAL POLICY

SECTION 2.1 DEFINITIONS

The following definitions shall be applicable to these standards and are in addition to those indicated in SECTION I of Standards Specifications:

- A. "DEVELOPER" includes subdivider and any person seeking to have the County accept or include in its maintained system any street or drainage facility.
- B. "PAVING WIDTH" the specified width of paving and roadbeds is measured from curb face to curb face. In the absence of curbs, the width of paving and roadbeds is measured from the edges of the paving or edges of the roadbed.
- C. "STANDARD DRAWINGS" means those drawings approved by the Board of Supervisors and adopted by said Board as a part of these specifications.
- D. "STREET" includes roads and highways. The terms street, road, and highway are used interchangeably and refer to the rights-of-way used for vehicular traffic, and, except in the case of freeways, for pedestrian traffic.
- E. LEVEL OF SERVICE A:

A condition of free unobstructed flow, no delays and all signal phases sufficient in duration to clear all approaching vehicles. Level of comfort for the motorist is excellent.
- F. LEVEL OF SERVICE B:

Conditions of stable flow, very little delay, a few phases are unable to clear all approaching vehicles, but the presence of other users in the traffic stream begins to be noticeable and affect behavior.
- G. LEVEL OF SERVICE C:

Conditions of stable flow. Individual operation is significantly affected by others in the traffic stream. The general level of comfort declines noticeably at this level.

H. LEVEL OF SERVICE D:

Conditions approaching unsuitable flow, delays are moderate to heavy, significant signal time deficiencies are experienced for short durations during the peak traffic period. Small increases in traffic flow will generally cause operational problems.

I. LEVEL OF SERVICE E:

Conditions of unstable flow, delays are significant, signal phase timing is generally insufficient, congestion exists for extended durations throughout the peak period. Comfort and convenience levels are extremely poor.

J. LEVEL OF SERVICE F:

Conditions at forced flow, travel speeds are low and volumes are well above capacity. This condition is often caused when vehicles released by an upstream signal are unable to proceed because of backups from a downstream signal. Operations are characterized by stop and go waves, drivers are very uncomfortable.

K. "TRAFFIC INDEX" is a number or "index" value used in design, which represents the effects of both composition and intensity of truck and auto traffic.

SECTION 2.2 PLAN APPROVAL

The developer shall cause to be prepared, in accordance with these standards, and submitted to the Director of Transportation for approval, plans, profiles and specifications for the proposed improvement of all streets, easements, and drainage ways. The developer shall obtain the approval of the County Director of Transportation of said plans, profiles and specifications prior to commencing any construction.

SECTION 2.3 STANDARD INTERPRETATION

Where the requirements for any road and drainage improvements are not specified in these standards, such requirements may be specified by Planning Commission, or Board of Supervisors in its resolution approving or conditionally approving the tentative map, or, if not specified in such resolution, by the Director of Transportation. Such requirements shall conform to accepted engineering standards, developed by the Director of Transportation or by national authorities, technical or scientific organizations. The requirements should reflect the cooperation between cities, state and county in maintaining consistent standards for public thoroughfares.

SECTION 2.4 PAYMENT OF IMPROVEMENTS

All improvements required by these standards shall be constructed and installed by the developer at his expense, unless otherwise approved.

SECTION 2.5 SUBDIVISION DEVELOPMENT

When submitting a tentative map for the subdivision of only a portion of an owner's tract of land, the subdivider, upon request of the Development Review Committee (DRC), shall submit a possible future development plan of the remaining portion of the tract and surrounding areas. This plan shall indicate a general lay-out of streets and shall be clearly labeled: "NOT A PART - POSSIBLE FUTURE DEVELOPMENT". Approval of the tentative map shall not constitute approval of the possible future development plan.

SECTION 2.6 ROAD ACCESS

The streets within a new subdivision and each phase thereof shall provide for two means of access to either a street in the County Maintained Road System, an improved State Highway or an improved city street one of which may be emergency only as required by the "San Bernardino County Development Code". Where it can be shown that this requirement is a physical impossibility or a cul-de-sac is proposed, the secondary access may be waived. Where an off-site connection is necessary to provide access to such street or highway, the subdivider shall acquire the right-of-way and construct the improvements required.

SECTION 2.7 WIDENING EXISTING IMPROVEMENTS

Where land abutting an existing substandard street is subdivided, the subdivider shall dedicate any necessary additional right-of-way and improve such street to conform to these standards.

SECTION 2.8 DESIGN OF STREET SYSTEMS

The design of street systems, including right-of-way and improvement widths, shall be in accordance with San Bernardino County standards and specifications and shall provide:

- A. Adequate local service for the area being developed.
- B. The Circulation Element of the General Plan.
- C. Adequate capacity for the development of adjacent lands.

- D. That the main access to any school shall meet the requirements for a two-lane residential collector street.
- E. Acceptable design standards such as "A Policy on Geometric Design of Highways and Streets, American Association of State Highway and Transportation Officials (AASHTO)".
- F. Design capacity of Level of Service "C" for the County Circulation Element as prescribed by Director of Transportation.

SECTION 2.9 UTILITY INSTALLATION

All utilities shall be designed, constructed, and installed in accordance with all applicable County requirements and State laws. Underground utilities to be located within street rights-of-way shall be installed prior to surfacing the streets.

ARTICLE III
DESIGNATION
OF
STREETS

ARTICLE III

DESIGNATION OF STREETS

SECTION 3.1 PURPOSE

For the purpose of these standards, the following street designations shall apply.

SECTION 3.2 MAJOR ARTERIAL (120'/104')

- A. Six lane highway with access control which may have grade separations at intersections.
- B. Design capacity for Level of Service "C" of 45,000 vehicles per day for Divided Arterial and 40,000 with continuous left turn lane.
- C. Striped for three lanes with shoulders in each direction with turn lanes at intersections. Additional rights of way and roadway widths may be necessary for turn lanes.

SECTION 3.3 MAJOR DIVIDED HIGHWAY (120'/94')

- A. Divided four lane with intersections at grade and control access.
- B. Design capacity for Level of Service "C" of 30,000 vehicles per day.
- C. Striped for two lanes with shoulders in each direction with a raised median and turn lanes. Additional rights of way and roadway widths may be necessary for turn lanes.

SECTION 3.4 MAJOR HIGHWAY/MOUNTAIN EXPRESSWAY (104'/80')

- A. Four lane highway with intersections at grade and access control.
- B. Design capacity for Level of Service "C" of 30,000 vehicles per day for Divided Highway and 24,000 with continuous left turn lane.
- C. Striped for two lanes with shoulders in each direction and turn lanes at intersections. Additional rights-of-way and roadway widths may be necessary for turn lanes.

SECTION 3.5 SECONDARY HIGHWAY (88'/64') MOUNTAIN MAJOR (80'/64')

- A. Four lane highway with intersections at grade and access control.

- B. Design capacity for Level of Service "C" of 20,000 vehicles per day.
- C. Striped for two lanes with shoulders in each direction. Turn lanes at intersections when necessary will require additional rights-of-way and roadway widths.

SECTION 3.6 CONTROLLED LIMITED/ACCESS COLLECTOR (66'/44')

- A. A street other than a major highway or secondary highway with controlled access.
- B. Normally accommodates traffic from local streets and distributes it onto four lane highways. Traffic volumes are not expected to require a Secondary or Major Highway.
- C. Design capacity for Level of Service "C" of 10,000 vehicles per day. (Service flow rate 1000 vehicles/hour)
- D. Striping for two through lanes and one left turn lane at intersections.

SECTION 3.7 COLLECTOR STREET (66'/44')

- A. Collector Streets are designed to provide principal access to residential areas where low traffic volumes allow direct access.
- B. Design capacity of 5,000 vehicles per day. Traffic capacity for this road category is limited not by the physical capacity of the road section, but rather by the desirability of maintaining an acceptable traffic level which will not adversely affect residential neighborhood qualities.
- C. Striping for two through lanes and when necessary one left turn lane at intersections.

SECTION 3.8 INDUSTRIAL LOCAL (60'/44')

- A. An Industrial Street to be utilized to serve industrial land or commercial uses.
- B. Additional widening may be required at intersections in order to provide for truck turning movements.

SECTION 3.9 MOUNTAIN SECONDARY (60'/44')

- A. A two lane highway with access control.
- B. Striping for two through lanes and one left turn lane at intersections.

- C. Design capacity of Level of Service "C" of 10,000 vehicles per day.

SECTION 3.10 LOCAL STREET (60'/40')

- A. Local Street is a street which is abutted by residential units.
- B. Additional widening may be required at intersections where a left turn lane is required.
- C. Maximum traffic volume not to exceed 2,000 vehicles per day.

SECTION 3.11 LOCAL STREET (less than 500 ADT)

- A. This local street is intended to serve single family residents and may also function as a cul de sac.
- B. Maximum traffic volume not to exceed 500 vehicles per day.

SECTION 3.12 MOUNTAIN LOCAL (40'/26')

Mountain Local is a two lane street with asphalt berms which will primarily serve residential units. The design capacity for Level of Service "C" of 700 vehicles per day.

SECTION 3.13 HALF-WIDTH STREET

Half width street is a street lying along a subdivision boundary for which only part of the right-of-way is to be presently dedicated.

SECTION 3.14 FRONTAGE ROAD

Frontage road is a road which is auxiliary to and located adjacent to a freeway, major highway, or arterial street, and which provides service to abutting property and adjacent areas and control of access to the adjacent major route. A frontage road may be of any street designation.

SECTION 3.15 ALLEY

Alley is a non county maintained secondary means of access usually lying along the rear of lots or property and has primary access from a street.

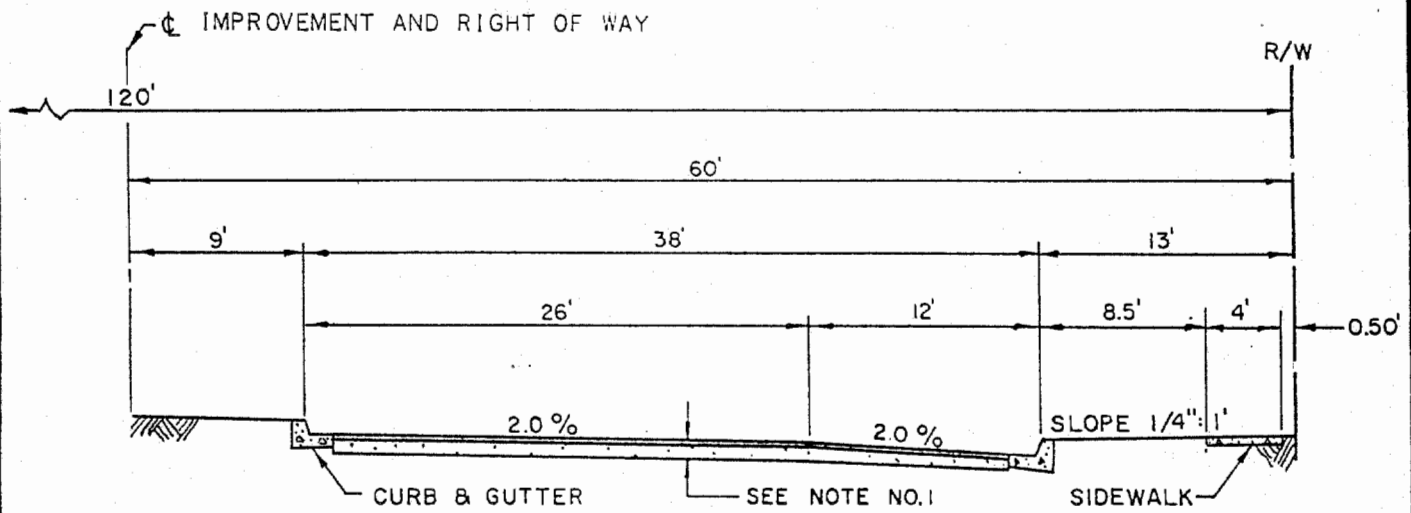

TYPICAL HALF SECTION

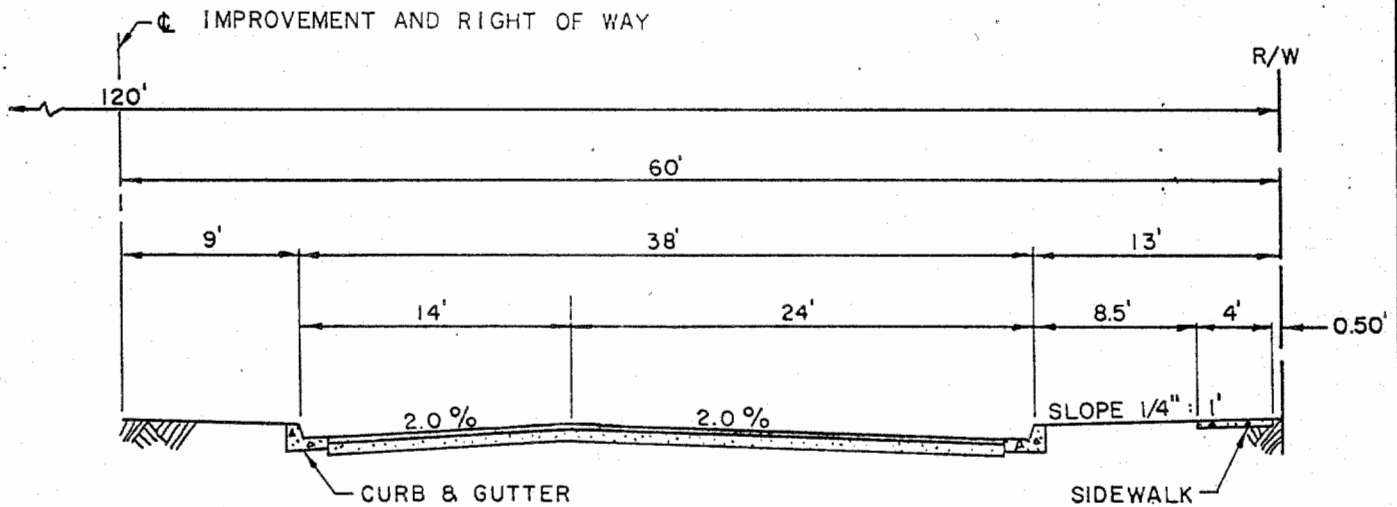

TYPICAL HALF SECTION

NOTES:

1. STRUCTURAL SECTION OF ROADWAY SHALL BE DETERMINED FROM SOILS TESTS AND SO INDICATED ON CONSTRUCTION PLANS.
2. CONSTRUCTION OUTSIDE R/W LINE SHALL REQUIRE SLOPE EASEMENTS.

SAN BERNARDINO COUNTY ROAD DEPARTMENT

DATE: F.V.C. 6-65
R.E. 4-92

KEN A. MILLER
Director of Transportation

MAJOR DIVIDED
HIGHWAY

100.

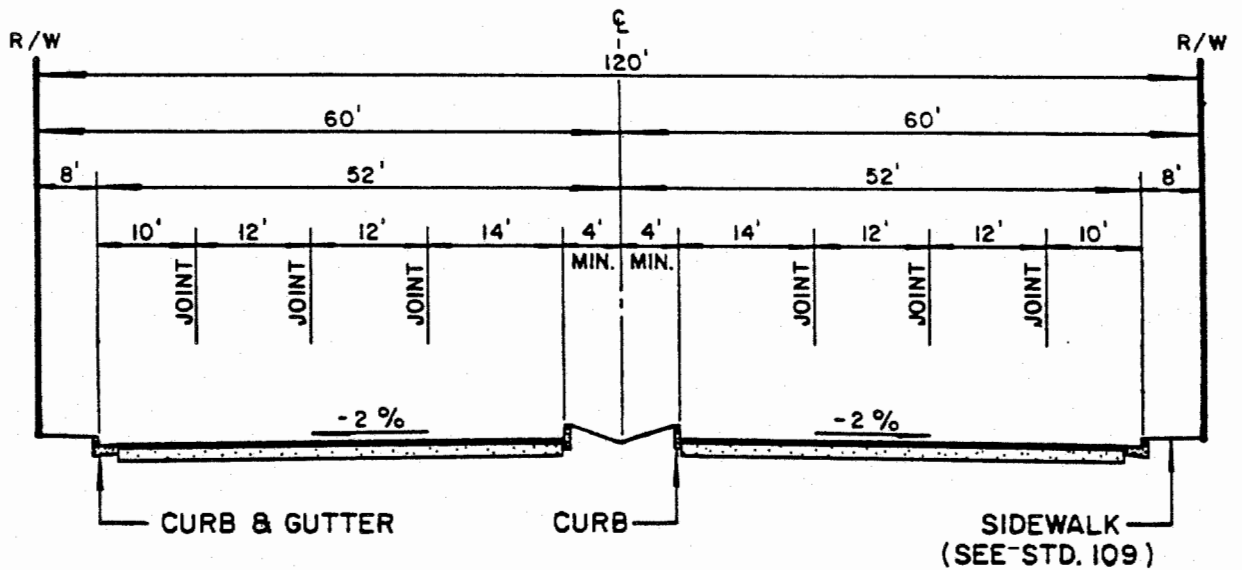

**TYPICAL SECTION
WITH RAISED MEDIAN**

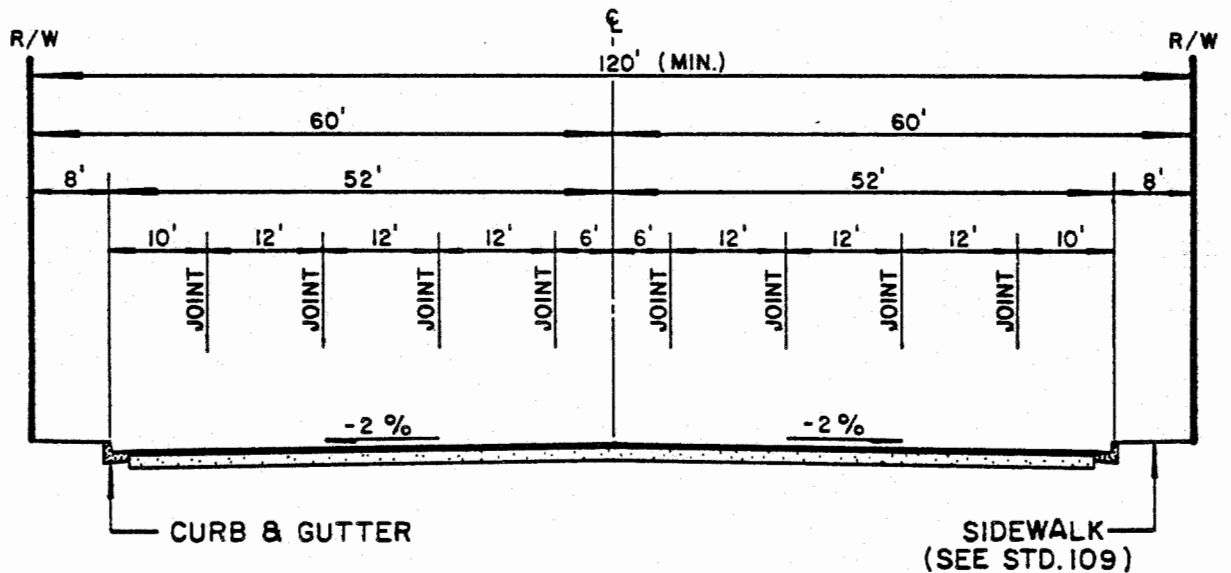

**TYPICAL SECTION
WITH CONTINUOUS LEFT TURN LANE**

NOTES:

1. STRUCTURAL SECTION OF ROADWAY SHALL BE DETERMINED FROM SOILS TESTS AND SO INDICATED ON CONSTRUCTION PLANS.
2. DRAINAGE FACILITIES SHALL BE PROVIDED TO DEWATER RAISED MEDIAN AREAS.
3. 10' SHOULDER AREAS MAY BE DESIGNATED AS A BIKE LANE AND EMERGENCY PARKING ONLY.

SAN BERNARDINO COUNTY TRANSPORTATION DEPARTMENT

DATE: 100 12 81

JOHN R. SHONE
DIRECTOR OF TRANSPORTATION

MAJOR ARTERIAL

**100
A**

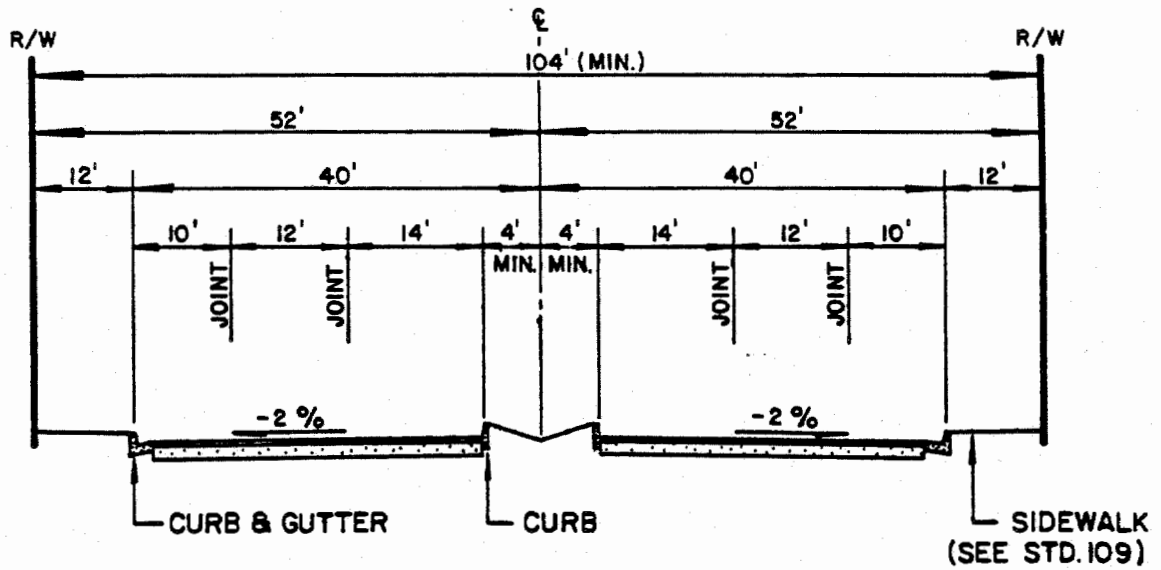

**TYPICAL SECTION
WITH RAISED MEDIAN**

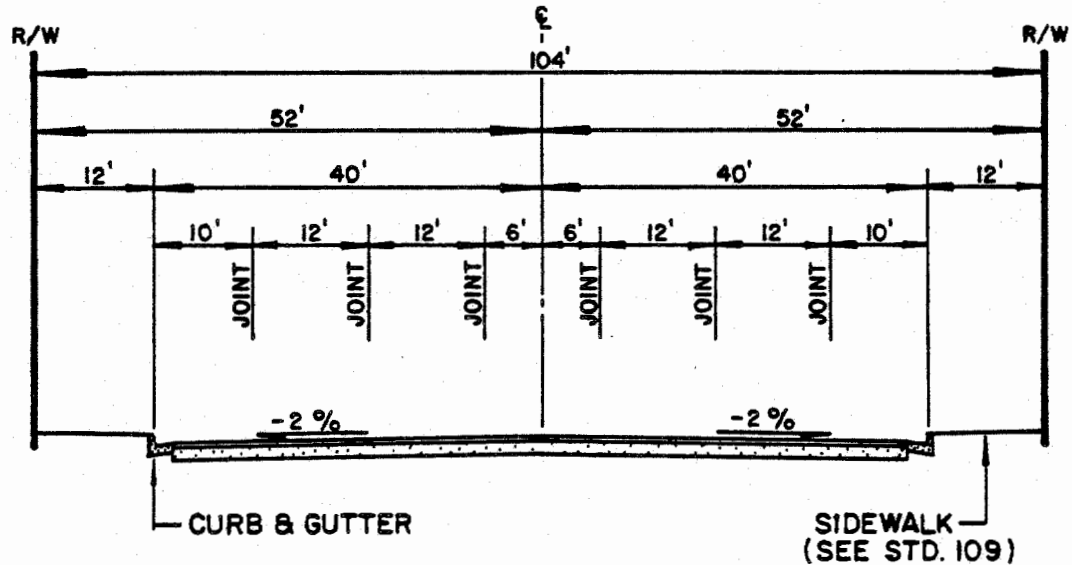

**TYPICAL SECTION
WITH CONTINUOUS LEFT TURN LANE**

NOTES:

1. STRUCTURAL SECTION OF ROADWAY SHALL BE DETERMINED FROM SOILS TESTS AND SO INDICATED ON CONSTRUCTION PLANS.
2. DRAINAGE FACILITIES SHALL BE PROVIDED TO DEWATER RAISED MEDIAN AREAS.
3. 10' SHOULDER AREAS MAY BE DESIGNATED AS A BIKE LANE AND EMERGENCY PARKING ONLY.

SAN BERNARDINO COUNTY TRANSPORTATION DEPARTMENT

DATE: 160 12 '81

JOHN R. SHONE
DIRECTOR OF TRANSPORTATION

MAJOR HIGHWAY

101

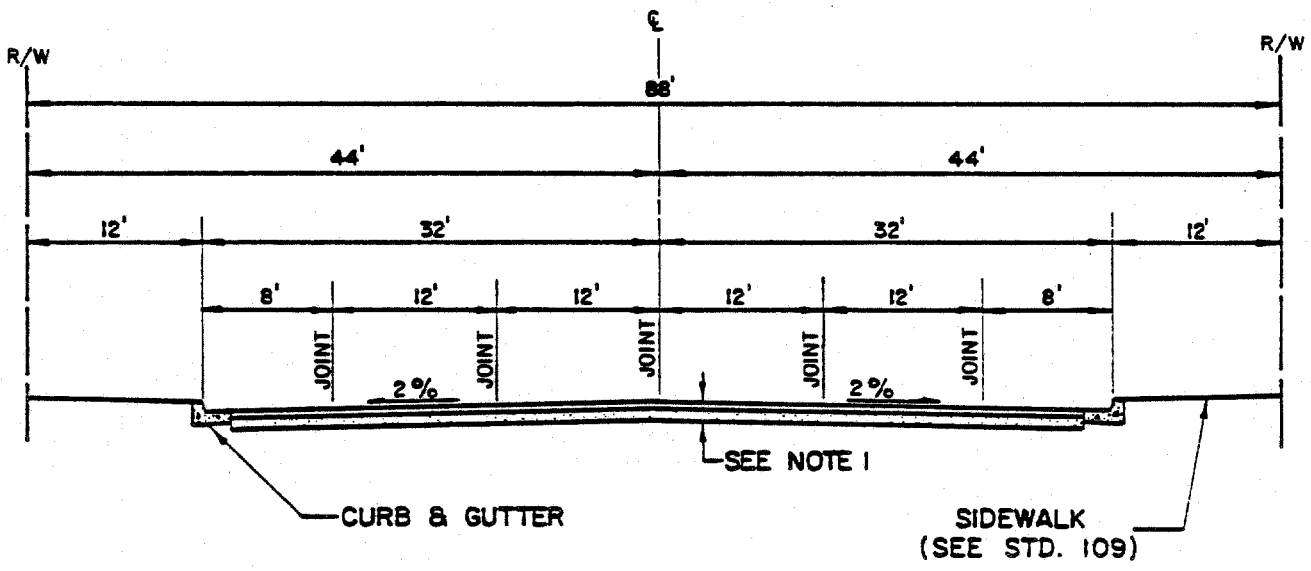

TYPICAL SECTION

NOTES:

1. STRUCTURAL SECTION OF ROADWAY SHALL BE DETERMINED FROM SOILS TESTS AND SO INDICATED ON CONSTRUCTION PLANS.
2. 8' SHOULDER AREAS MAY BE DESIGNATED AS A BIKE LANE AND EMERGENCY PARKING ONLY.

SAN BERNARDINO COUNTY TRANSPORTATION DEPARTMENT		SECONDARY HIGHWAY	102
DATE: <i>VRK 4 '77</i> <i>RPL 12 '81</i>	JOHN R. SHONE DIRECTOR OF TRANSPORTATION		

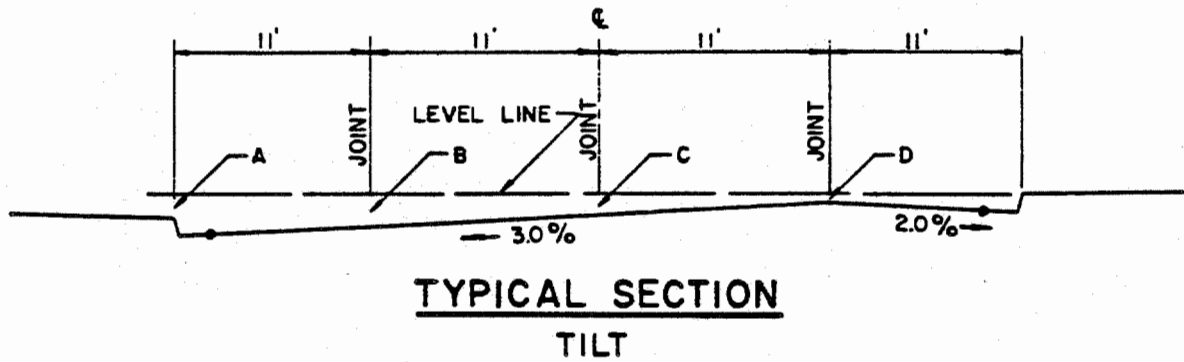
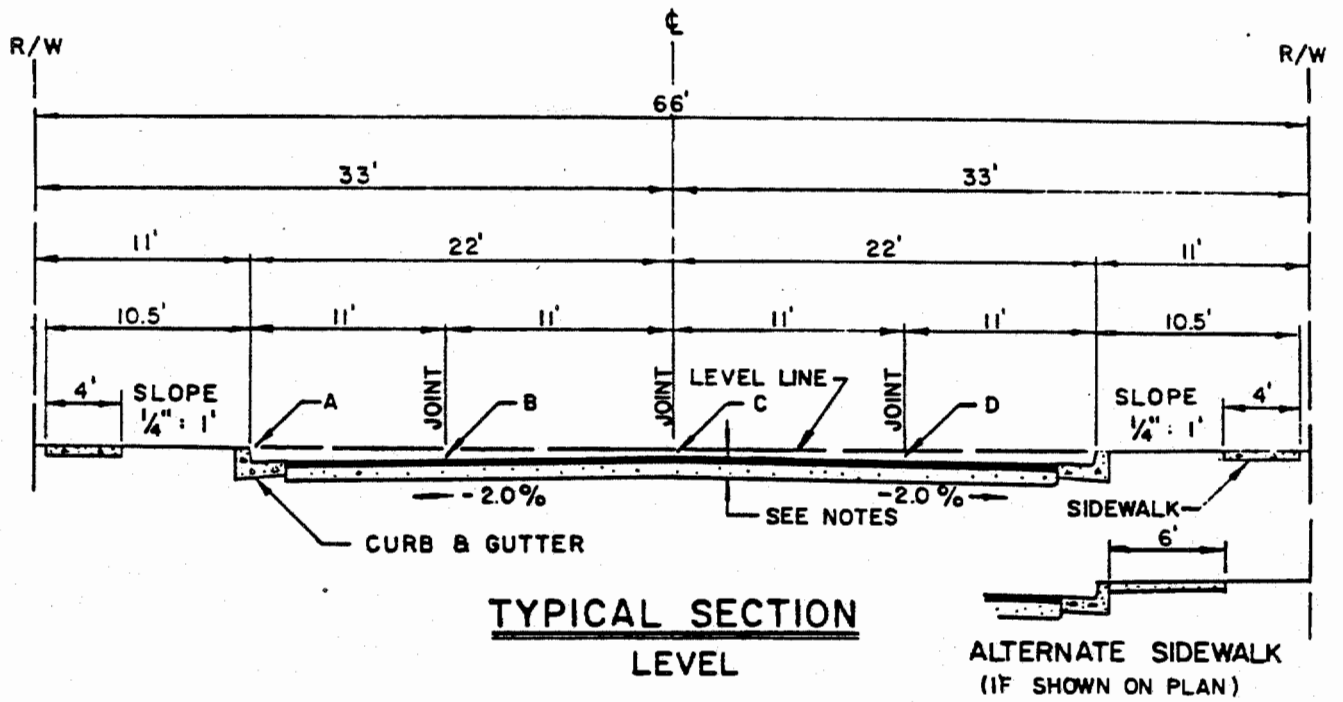

		A	B	C	D	
8" CURB	LEVEL	0.00'	0.36'	0.14'	0.36'	
	TILT	0.76'	1.02'	0.69'	0.36'	
6" CURB	LEVEL	0.00'	0.19'	(0.03)	0.19'	() INDICATES ABOVE LEVEL LINE
	TILT	0.76'	0.85'	0.52'	0.19'	

NOTE

- STRUCTURAL SECTION OF ROADWAY SHALL BE DETERMINED FROM SOILS TESTS AND SO INDICATED ON CONSTRUCTION PLANS.
- MINIMUM DESIGN PAVING THICKNESS SHALL BE 0.25' ASPHALT CONCRETE.
- CONSTRUCTION OUTSIDE R/W WILL REQUIRE SLOPE EASEMENTS.

SAN BERNARDINO COUNTY ROAD DEPARTMENT

DATE: 3.V.C. 9-65

Rev. 5-74

John R. Shone
COUNTY HIGHWAY ENGINEER

COLLECTOR STREET

103

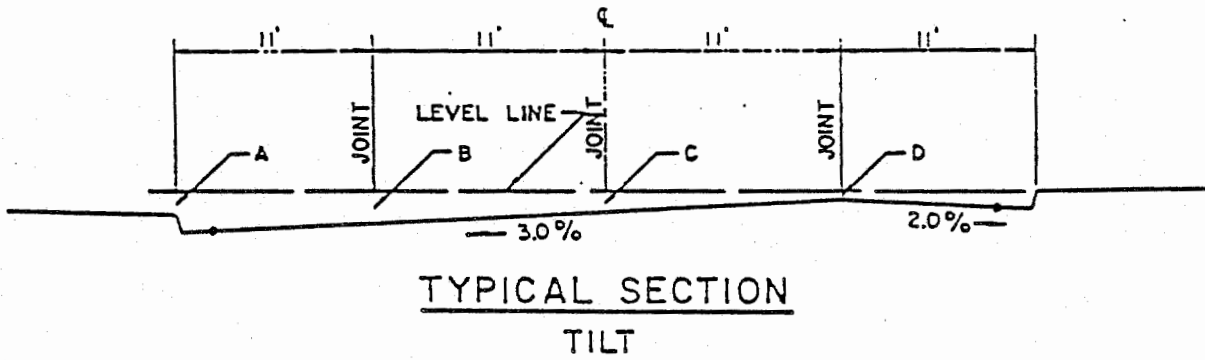
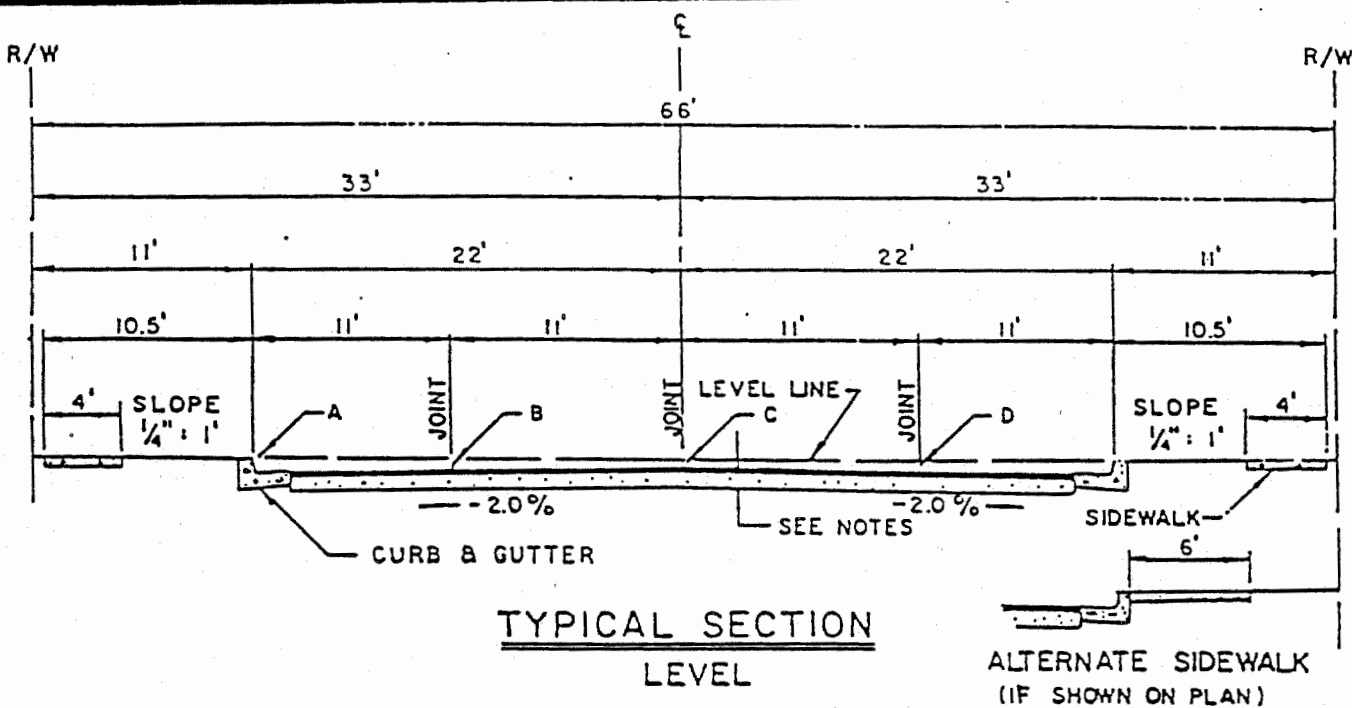

		A	B	C	D
8" CURB	LEVEL	0.00'	0.36'	0.14'	0.36'
	TILT	0.76'	1.02'	0.69'	0.36'
6" CURB	LEVEL	0.00'	0.19'	(0.03)	0.19'
	TILT	0.76'	0.85'	0.52'	0.19'

() INDICATES ABOVE LEVEL LINE

NOTE

1. STRUCTURAL SECTION OF ROADWAY SHALL BE DETERMINED FROM SOILS TESTS AND SO INDICATED ON CONSTRUCTION PLANS.
2. MINIMUM DESIGN PAVING THICKNESS SHALL BE 0.25' ASPHALT CONCRETE.
3. CONSTRUCTION OUTSIDE R/W WILL REQUIRE SLOPE EASEMENTS.

SAN BERNARDINO COUNTY TRANS. DEPT.

 KEN A. MILLER
 Director of Transportation

CONTROLLED LIMITED
 ACCESS COLLECTOR

103 A

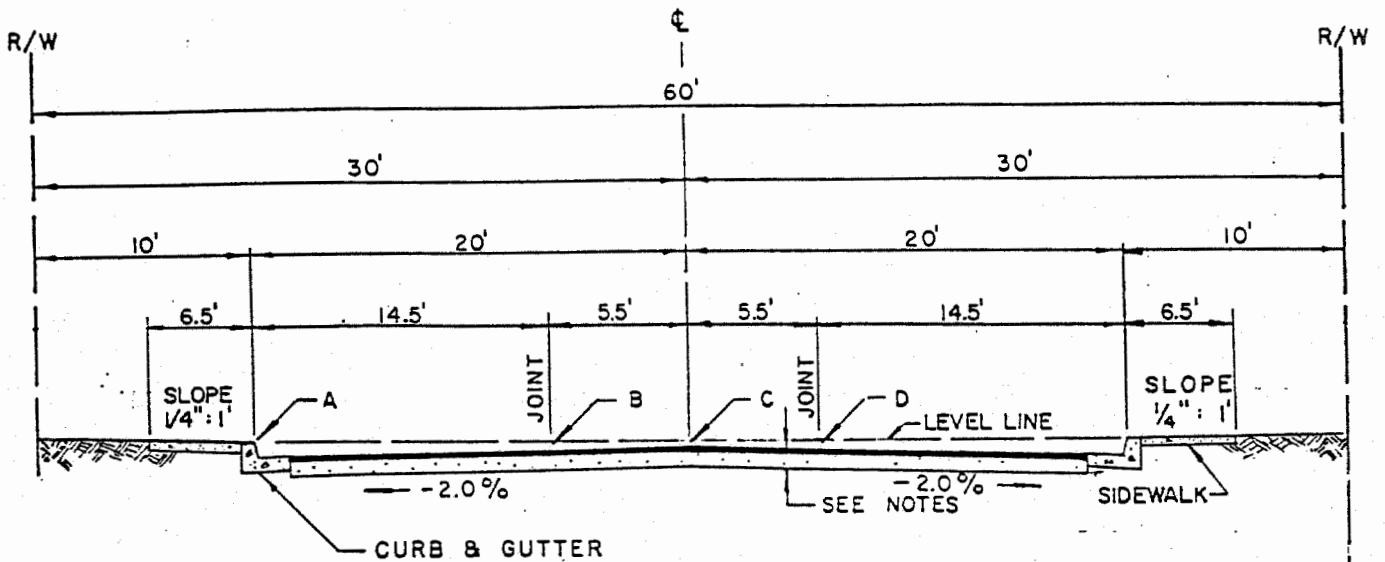

TYPICAL SECTION
LEVEL

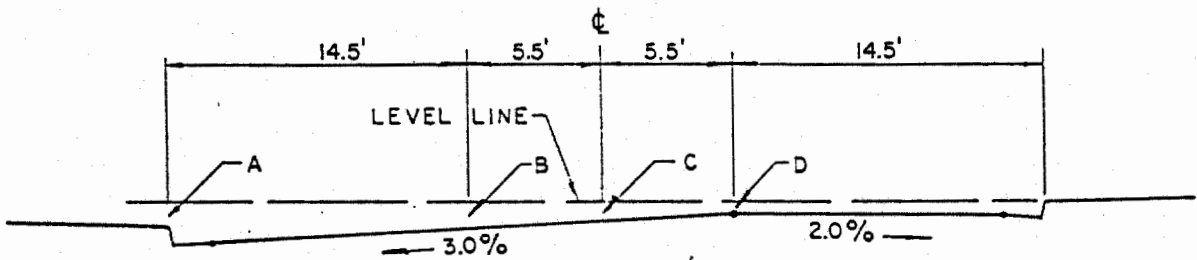

TYPICAL SECTION
TILT

		A	B	C	D
8" CURB	LEVEL	0.00'	0.29'	0.18'	0.29'
	TILT	0.46'	0.62'	0.46'	0.29'
6" CURB	LEVEL	0.00	0.12'	0.01'	0.12'
	TILT	0.46'	0.45'	0.29'	0.12'

NOTE

1. STRUCTURAL SECTION OF ROADWAY SHALL BE DETERMINED FROM SOILS TESTS AND SO INDICATED ON CONSTRUCTION PLANS.
2. MINIMUM DESIGN PAVING THICKNESS SHALL BE 0.25' ASPHALT CONCRETE.
3. CONSTRUCTION OUTSIDE R/W WILL REQUIRE SLOPE EASEMENTS
4. WHEN PREPARING SUBGRADE FOR PAVING, CENTERLINE CROWN ON THE "LEVEL SECTION" SHALL BE RELOCATED EITHER LEFT OR RIGHT 0.50' TO MATCH CROWN BREAK IN PAVING MACHINE.

SAN BERNARDINO COUNTY TRANS. DEPT.		LOCAL STREET	104
DATE: F.V.C. 9-65			
Rev. 5-74			
R.I. 12-91			

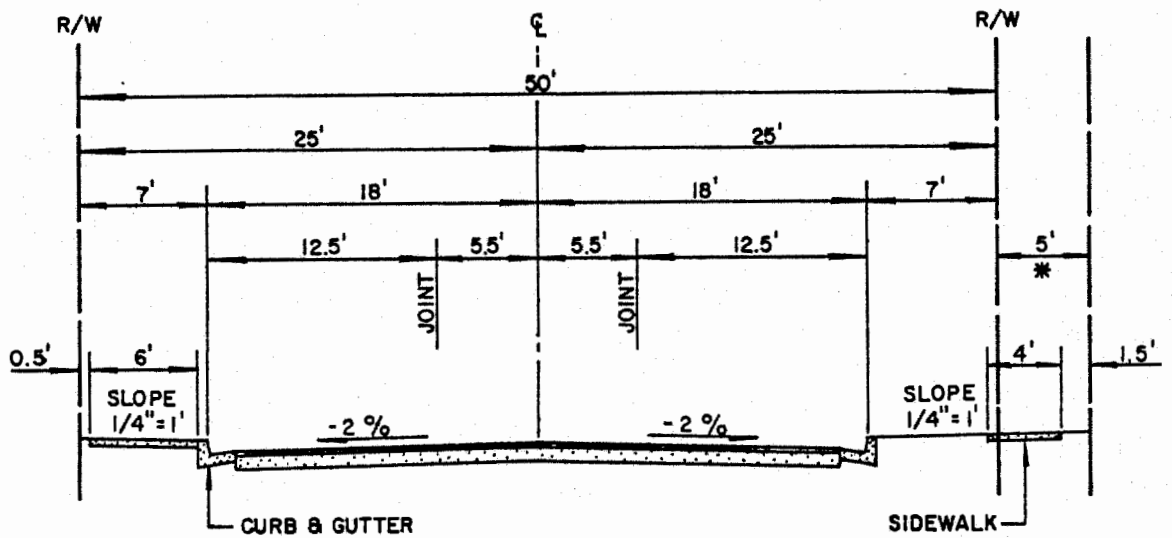

TYPICAL SECTION

NOTES:

1. THIS TYPICAL SECTION SHALL BE USED ONLY ON LOCAL STREETS SUCH AS CUL-DE-SACS, LOOPS AND STREETS THAT DO NOT CARRY THROUGH TYPE TRAFFIC. THE USE SHALL BE LIMITED TO STREETS WHICH ARE PROJECTED TO CARRY LESS THAN 500 ADT UPON ULTIMATE DEVELOPMENT OF THE AREA.
2. STRUCTURAL SECTION OF ROADWAY SHALL BE DETERMINED FROM SOIL TESTS AND SO INDICATED ON CONSTRUCTION PLANS.
3. CONSTRUCTION OUTSIDE R/W LINE SHALL REQUIRE SLOPE EASEMENTS.
4. TILT SECTION SHALL CONFORM TO LOCAL STREET STANDARD NO. 104.
- *. 5' WIDE SIDEWALK AND PUBLIC UTILITIES EASEMENT AT THE OPTION OF THE OWNER, THIS AREA MAY BE DEDICATED AS ROAD RIGHT-OF-WAY.

SAN BERNARDINO COUNTY TRANSPORTATION DEPARTMENT

DATE: 1GO 12 '81

JOHN R. SHONE
DIRECTOR OF TRANSPORTATION

LOCAL STREET
(LESS THAN 500 ADT)

104
A

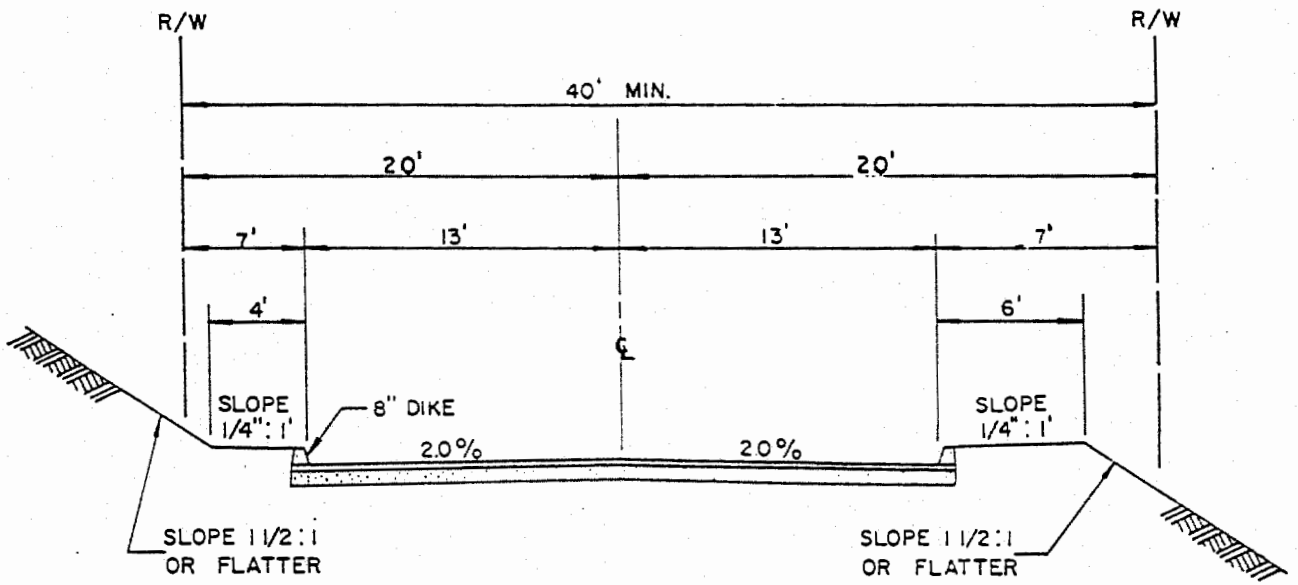

TYPICAL SECTION
MOUNTAIN AREAS

NOTES:

1. STRUCTURAL SECTION OF ROADWAY SHALL BE DETERMINED FROM SOILS TESTS AND SO INDICATED ON CONSTRUCTION PLANS.
2. CONSTRUCTION OUTSIDE R/W LINE SHALL REQUIRE SLOPE EASEMENTS.
3. SLOPE REQUIREMENT MAY BE VARIED BY SUBMISSION OF SOILS REPORT.

SAN BERNARDINO COUNTY ROAD DEPARTMENT		MOUNTAIN LOCAL PAVED ROAD	114b
DATE: J.E.M. 9-65 P.R. 8-80 R.E. 4-92	KEN A. MILLER Director of Transportation		

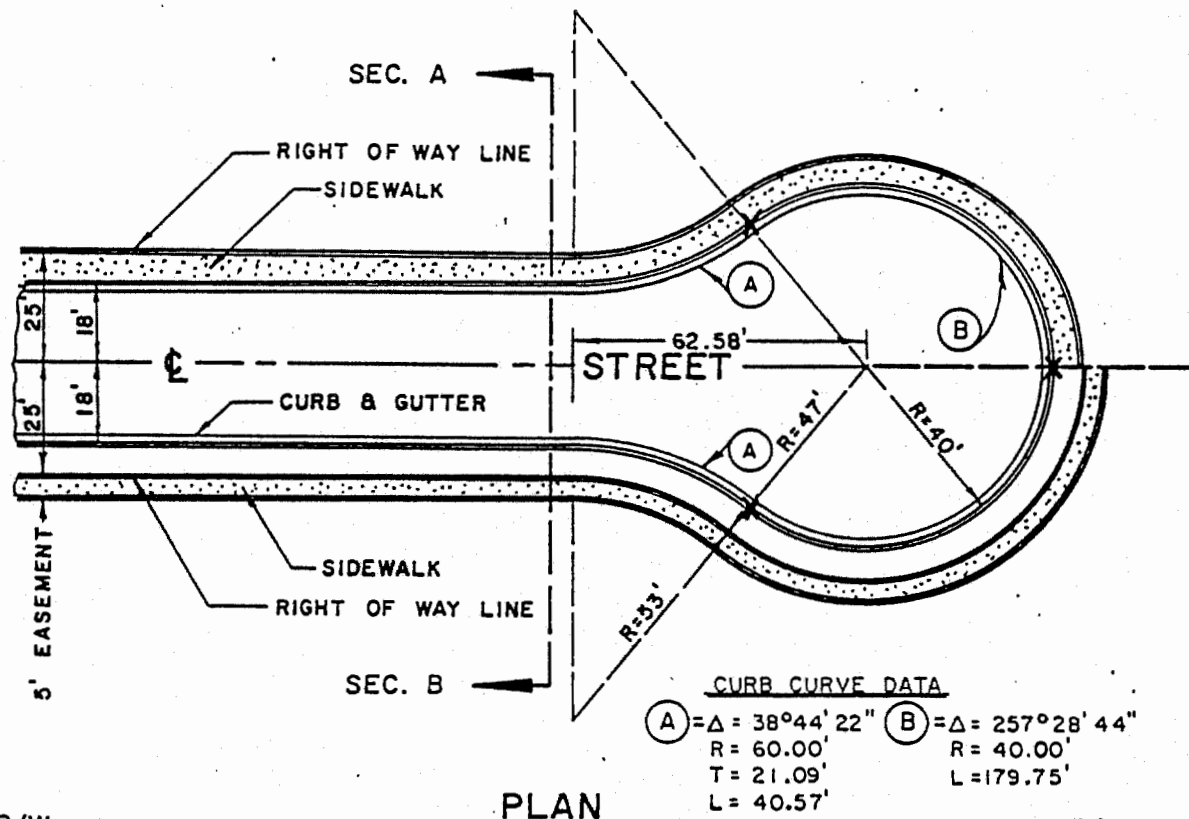

CURB CURVE DATA

(A) $\Delta = 38^{\circ}44'22''$	(B) $\Delta = 257^{\circ}28'44''$
R = 60.00'	R = 40.00'
T = 21.09'	L = 179.75'
L = 40.57'	

PLAN

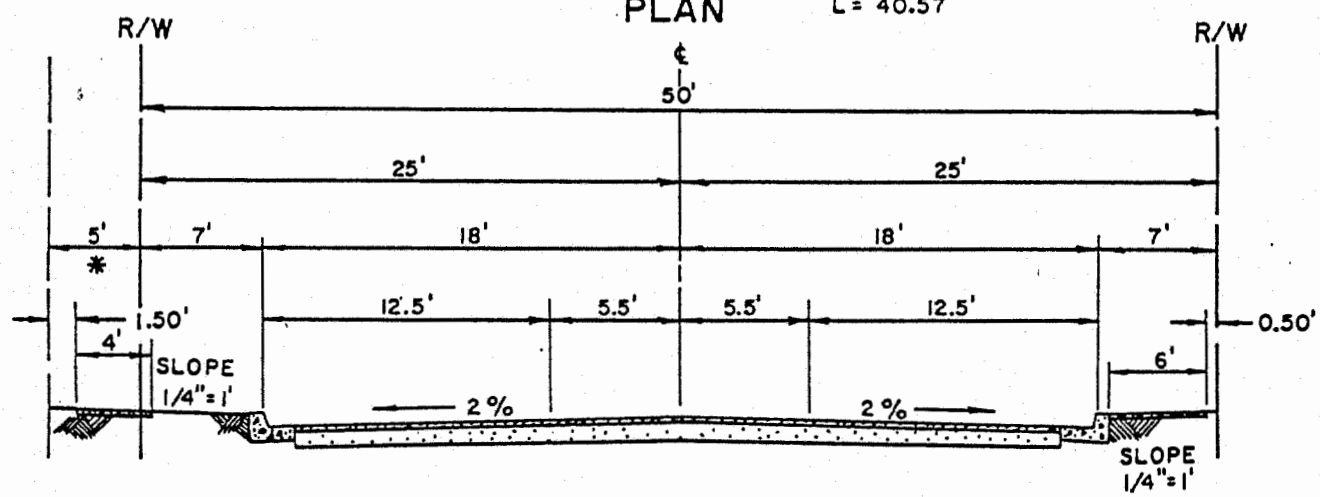

SEC. B

TYPICAL SECTION

SEC. A

NOTES:

1. STRUCTURAL SECTION OF ROADWAY SHALL BE DETERMINED FROM SOIL TESTS AND SO INDICATED ON CONSTRUCTION PLANS.
2. CONSTRUCTION OUTSIDE R/W LINE SHALL REQUIRE SLOPE EASEMENTS.
3. 0.6% GRADE MIN. ON GUTTER OF BULB.
4. TILT SECTION SHALL CONFORM TO LOCAL STREET STANDARD NO. 104.
- * 5' WIDE SIDEWALK AND PUBLIC UTILITIES EASEMENT AT THE OPTION OF THE OWNER, THIS AREA MAY BE DEDICATED AS ROAD RIGHT OF-WAY.
6. X Indicates position of survey reference point (#10 Round Head Brass Screw minimum length 1/4") set flush with top of curb during construction.

San Bernardino County Transportation Department	John R. Shone DIRECTOR OF TRANSPORTATION	CUL - DE - SAC	120
Rev. VEH 2-79			

ARTICLE IV
IMPROVEMENT LEVELS

ARTICLE IV

IMPROVEMENT LEVELS

SECTION 4.1 DEFINITION

New residential, commercial or industrial uses will demand the provision of additional public facilities and services. In several areas, major public service and facility deficiencies already exist. Projected growth may add to this problem and may create new problems in other areas as well. In order to ensure that future developments do not become fiscal liabilities to County residents, policies were developed to require that future development proceeds at a pace commensurate with the provision of services.

The County recognizes that there is a direct relationship between the intensity of land uses and the amounts of facilities and services that are needed to support such uses. Analyses of subdivision and development activities in the County show that there are basically five levels of development intensity, ranging from very high density developments in urban areas, to very low density developments in very rural areas. The amount of infrastructure facilities and services required in areas with high density development is significantly more than that required in areas with low density development. Thus, the County established on-site and off-site improvement standards that are deemed essential in each of the five different levels of development intensity. This system of matching development intensity with essential improvements is referred to as the "Improvement Level System (ILs)."

Five ILs were established to correspond with the five different intensity levels. At the one end of the scale, IL 1 is applied to very urban areas, while at the other end of the scale, IL 5 is applied to very rural areas. Improvement Levels are assigned to an area based on the long-term planned development and lifestyle commitment of the area. Future development is expected to provide the appropriate and applicable infrastructure facilities and services prior to, or in concert with anticipated or proposed development. The Improvement Level for each area is as depicted on the Infrastructure/Improvement Levels Overlay Map.

Figures 4-1, 4-2, and 4-3 list the required improvements for the five different levels of development intensity in the Valley, Mountain and Desert respectively. The Improvement Levels will be applied to all applications, including all building permits, in the future. Initially, however, they will be applied to the following:

All divisions of land

All commercial, industrial and institutional use applications

Multiple family residential use applications

Discretionary single-family residential use applications

Applicants requesting building permits for single-family residential units on parcels that were legally created prior to the adoption of this plan shall be exempt from Improvement Level requirements unless required by various departmental standards such as the interim development standards adopted in September, 1988. The Improvement Level Standards shall be implemented by standards and guidelines available with applications.

SECTION 4.2 APPLICATION OF IMPROVEMENT LEVEL

A. Improvement Level (IL) 1

Level 1 is applied to those areas planned for the most dense and highest intensity level of development. This may include large areas designated for commercial, industrial or multi-family residential uses, city spheres of influence areas planned for high-density uses, and higher-density single family residential uses. In most cases, IL 1 is suitable in what may be considered the core areas of established urban or urbanizing communities.

Typical Ultimate Lot Size: less than 1/2 Acre.

B. Improvement Level (IL) 2

Level 2 is applied to areas where the planned density of development in the short term is relatively high, and areas that are partially developed and/or subdivided at an established land use pattern predominately of one acre or less in size, and where existing infrastructure facilities and distribution systems are largely in place.

Typical Ultimate Lot Size: 1/2 Acre to 1 Acre

C. Improvement Level (IL) 3

Level 3 is typically applied to areas that may be considered "transitional", i.e., areas that are difficult to label either rural or urban. An example of a Level 3 area might be a low-density residential

area that is near an urban or urbanizing area. Such an area might have a significant amount of low-to-moderate density residential development or large acreage which is expected to convert to a higher density in the next five to ten years.

Typical Ultimate Lot Sizes: 1 acre to 5 acres

D. Improvement Level (IL) 4

Level 4 is applied to areas where only a limited amount of low-density development is planned or anticipated due to resource constraints and/or a desire to maintain a rural living environment. Required improvements are intended to protect the public health and safety and focus primarily on safe access and the availability of local or on-site water. These areas are not expected to convert to higher densities during the term of the Plan.

Typical Ultimate Lot Sizes - 5 Acres to 20 Acres

E. Improvement Level (IL) 5

Level 5 is applied to areas with little or no development potential, and where only very sparse development is expected in the long term. These areas are typically in remote or inaccessible locations, or in relatively vast open space areas where severe environmental and physical constraints or lack of resources virtually preclude development.

Typical Ultimate Lot Size: Greater than 20 Acres

EXCEPTIONS

Often land divisions occur where the land is divided into parcels larger than the minimum size allowed in the district. Where this occurs, strict application of the standards of the Improvement Level may not be necessary. For example, in areas designated IL 1 and 2, land may be divided into parcels of 5 acres and greater and be subject to the IL 4 standards. In areas designated IL 3, land may be divided into parcels of 10 acres and greater and meet the IL 4 standards. In both of the above instances, any of the standards of the Improvement Level in which the land lies may be applied if required for reasons of public health and safety.

Figure 4-1

Improvement Standards - Valley (shown on Infrastructure Overlay)

STANDARDS	IMPROVEMENT LEVELS				
	1	2	3	4	5
Legal and physical access	●	●	●	●	●
Grants of Easements*	●	●	●	●	●
Paved access	●	●	●**		
Curbs and gutters	●	●	●***		
Sidewalks	●	1/2****			
Street lights at standard spacing	●				
Street lights at midblock		●			
Street lights at intersections only			●		
Water purveyor	●	●	●		
Substantiated well water			● or ●****	●	
Sewer*****	●	●	●		
Septics	● or ●	● or ●	● or ●	●	●
Drainage improvements**	●	●	●		
Paved dip section	●	●	●	●	
Fireflow	●	●	●		
*Includes necessary rights-of-way for transportation and circulation, drainage and flood control facilities, and utilities.					
**The requirement will be waived in areas where a subregional plan and fee or other financing mechanism exists to provide necessary improvements. Provided, however, that the Transportation/Flood Control Department may require additional improvements if necessary for reasons of health and safety.					
***Curbs and gutters shall be required by the Transportation/Flood Control Department if necessary for reasons of health and safety.					
****Sidewalks may be required on both sides of the street by the Transportation/Flood Control Department if necessary for reasons of health and safety.					
*****Individual well allowed if site does not overlie aquifer in state of overdraft.					
*****Sewers shall be required as necessary by the EHS Department if necessary for reasons of health and safety.					

Figure 4-2

Improvement Standards - Mountain (shown on the Infrastructure Overlay)

STANDARDS	IMPROVEMENT LEVELS				
	1	2	3	4	5
Legal and physical access	●	●	●	●	●
Grants of easements*	●	●	●	●	●
Paved access	●	●	●**		
Curbs and gutters***	●	●			
Sidewalks***	●	1/2			
Street lights at intersections only	●	●			
Water purveyor	●	●	●		
Substantiated well water			● or ●****	●	
Sewer*****	●	●			
Septics	● or ●	● or ●	●	●	●
Drainage improvements**	●	●	●		
Paved dip section	●	●	●	●	
Fireflow	●	●	●		
*Includes necessary rights-of-way for transportation and circulation, drainage and flood control facilities, and utilities.					
**The requirement will be waived in areas where a subregional plan and fee or other financing mechanism exists to provide necessary improvements. Provided, however, that the Transportation/Flood Control Department may require additional improvements if necessary for reasons of health and safety.					
***Curbs, gutters and sidewalks may be required by the Transportation/Flood Control Department if necessary for reasons of health and safety. Asphalt berms may be required where curbs and gutters are not required.					
****Individual well allowed if site does not overlie aquifer in state of overdraft.					
*****Sewers shall be required as necessary by the EHS Department if necessary for reasons of health and safety.					

Figure 4-3

Improvement Standards - Desert (shown on Infrastructure Overlay)

STANDARDS	IMPROVEMENT LEVELS				
	1	2	3	4	5
Legal and physical access	●	●	●	●	●
Grants of easements*	●	●	●	●	●
Paved access	●	●	●**		
Curbs and gutters	●	●	●***		
Sidewalk	●	1/2****			
Street lights at standard spacing	●				
Street lights at intersections only		●			
Water purveyor	●	●	● or ●****		
Substantiated well water			●	●	
Sewer*****	● or ●	● or ●			
Septics	●	●	●	●	●
Drainage improvements**	●	●	●		
Fireflow	●	●	●		
*Includes necessary rights-of-way for transportation and circulation, drainage and flood control facilities, and utilities.					
**The requirements will be waived in areas where a subregional plan and fee or other financing mechanism exists to provide necessary improvements.					
***Curbs and gutters shall be required by the Transportation/Flood Control Department if necessary for reasons of health and safety.					
****Sidewalks may be required on both sides of the street by the Transportation/Flood Control Department if necessary for reasons of health and safety.					
*****Individual well allowed if site does not overlie aquifer in state of overdraft.					
*****Sewers shall be required as necessary by the EHS Department if necessary for reasons of health and safety.					
*****Provided, however, that the Transportation/Flood Control Department may require additional improvements if necessary for reasons of health and safety.					

ARTICLE V
STREET STANDARDS

**ARTICLE V
STREET STANDARDS**

SECTION 5.1 CURB AND GUTTER

Portland Cement Concrete curb and gutter is intended to serve one or more of the following purposes; drainage control, pavement edge delineation, reductions of maintenance, access control and for orderly development.

The concrete curb and gutter conforming to San Bernardino County Standards is the barrier type curb. This curb is normally required on new development in accordance with the County General Plan Mandate. The mountable curb may be used for private roads, where drainage is not a concern.

SECTION 5.2 SIDEWALKS

Sidewalks shall be portland cement concrete and shall conform to the following requirements:

- (A) Sidewalks shall be at least 4 inches thick, except where traversed by driveways, they shall conform to the requirements for driveways.
- (B) The back of the sidewalks shall be 10'6" from the curb face, except in the following instances:
 - (1) On local and collector streets when the street gradient exceeds 6%, the sidewalk shall be adjacent to the curb to aid in erosion control.
 - (2) When specific circumstances justify the use of sidewalks contiguous to the curb and the approval of the Land Development Engineer, Planning Commission, Director of Transportation, or Board of Supervisors has been obtained.
- (C) Whenever any portion of a sidewalk is offset from the normal location adjacent to the property line, the same offset shall be maintained continuously between street intersections.

SECTION 5.3 DRIVEWAYS

Driveways shall conform to County standards, the adopted Development Code and General Plan.

The location and number of access points are discussed in Article VI "Access".

SECTION 5.4 STREET NAME SIGNS

The developer shall install street name signs as a part of the improvements. Installation shall be in accordance with standard drawings and at the locations specified by the Director of Transportation. One (1) sign at each intersection will be required, except on four lane streets where two (2) signs will be required.

The installation of street name signs on existing County maintained streets, and the maintenance and replacement of all street name signs shall be at County expense.

Where street names are changed at local request, the expense of installing new street name signs shall be borne by the persons requesting the change.

SECTION 5.5 TRAFFIC SIGNS

The developer shall install all necessary traffic regulatory and warning signs at locations specified by the Director of Transportation as a part of the street improvements.

SECTION 5.6 SURVEY MONUMENTS

Boundary, lot corner and street survey monuments shall be installed as a part of the subdivision or street improvements as follows:

- A. Monuments and their installation shall conform to requirements of the County Surveyor's Subdivision Standards/Parcel Map Standards.
- B. The developer of any street other than in a new subdivision shall cause a licensed Land Surveyor or Registered Civil Engineer to:
 - (1) Re-set or preserve all existing monuments affected by the street improvements.
 - (2) Set such additional monuments to mark the limiting lines of the streets as the County Surveyor may require.

SECTION 5.7 MINIMUM STANDARDS

The standards set forth in this article are minimum and may be exceeded in order to provide a higher degree of safety.

ARTICLE VI

ACCESS

ARTICLE VI

ACCESS

SECTION 6.1 DRIVEWAY ACCESS LOCATION

The design, number, and location of access points must be approved by the Director of Transportation when the use of any property or its access operation is changed. The number of access points must be kept to a minimum. No access points will be approved without an approved project site plan.

All construction to connect driveways to County streets must first be authorized by a valid Encroachment Permit.

SECTION 6.2 ACCESS CHANGE

When there is a request for a building permit or land use approval, and the access is not in conformance with county standards, reconstruction, closure or relocation of the access may be required.

The following criteria may be considered in the determining if the access needs modification:

- A. The increase in actual or proposed vehicular volume at the access opening causes the road capacity to deteriorate to an unacceptable level of service.
- B. A particular directional characteristic (such as left turns) increases to cause deterioration of level of service.
- C. The change in use of the property or modifications to the property causes the flow of vehicles entering the property to be restricted or to queue or hesitate on the street creating a potential hazard.
- D. The use of the access by commercial or other large vehicles which would require large turning radius.
- E. If a parcel of land with direct road access has been in a state of non-use and recommencement of the access exceeds its design limitations or is non-conforming with the current County standards.
- F. If required for reasons of public health and safety as determined by the Director of Transportation.

SECTION 6.3 NUMBER OF ACCESS POINTS

- A. One access point per property ownership will be encouraged, unless a development or circulation plan with supporting data is provided to the satisfaction of the Director of Transportation or Fire Marshal indicating that more than one access is required to adequately handle driveway volumes, and will not be detrimental to traffic flow on adjacent public roads.

Where a property has access to more than one road, access will generally be limited to the lowest volume road where the impacts of a new access will be minimized. Access on other higher volume roads should be restricted.

- B. Joint access between adjacent developments is highly recommended and may be required on Secondary or Major Highways.
- C. Access location and alignment, if the parcel size permits, should be in centerline alignment with access located on opposite side of the street or a minimum offset per Table 6-1.

SECTION 6.4 ACCESS SPACING

Table 6-1 presents the access-drive spacing in non single residential use to eliminate overlap of the conflict areas created by a vehicle making a right turn from a driveway and entering the through traffic stream. Thus, it represents the minimum driveway spacing which allows the driver of a through vehicle to monitor one driveway at a time, rather than two or more simultaneously. The access spacing may need to be increased if left turn lanes are being proposed.

TABLE 6-1

Minimum Distance to Reduce Collision Potential Due to Right-Turn Conflict Overlap

Speed (mph)	Minimum Spacing (feet) ^a		
	Author ^b		Glennon, et al. ^e
	Preferable ^c	Limiting ^d	
30	185	100	125
35	245	160	150
40	300	210	185
45	350	300	230

SOURCE: Vergil G. Stover [27].

^aSpacing allows drivers in the through-traffic stream to consider one access drive at a time. It requires that a through vehicle decelerate in order to avoid a collision when a vehicle enters the through-traffic lane.

^bMeasured center to center of access drives.

^cA vehicle entering the traffic stream from a driveway completes the 90-degree right turn and accelerates from a stop at 2.0 fps². The vehicle in the outside through-traffic lane does not change lanes and decelerates at 6.0 fps² after a 2.0-second perception–reaction time. No clearance is provided between the through vehicle and the vehicle entering from the driveway. The implied speed differentials between the driveway vehicle and the through traffic stream are:

Arterial speed, mph	30	35	40	45
Speed differential, mph	20	24	28	32

^dThe driveway vehicle completes the 90-degree right turn and accelerates at an average of 3.1 fps². The through vehicle decelerates at an average of 6.0 fps² after a one-second perception–reaction time. No clearance is provided between the vehicles. The implied speed differentials are

Arterial speed, mph	30	35	40	45
Speed differential, mph	14	19	24	29

The lower speed differentials for the "limiting" case result from the higher assumed acceleration rate of the driveway vehicle.

^eMeasured near curb to near curb. Assumes: 8.5 fps² by the through vehicle; driveway vehicle accelerates at an average of 2.1 fps² for a 30-mph speed and an average of 1.7 fps² for all higher speeds.

SECTION 6.6 RESIDENTIAL DRIVEWAY

- A. Driveways serving property used solely as a single family, two-family, or three-family residence, including farms and ranches not used for retail outlets, shall be residential type driveways conforming to standard drawings.
- B. At intersections of Collector Roads with Secondary Highways or Major Highways, the minimum distance between the nearest edge of driveway and curb return on the Collector Roads shall be a minimum distance of 75 feet except 50 feet may be permissible if the design ADT on the Collector Road is less than 3,000.

SECTION 6.7 COMMERCIAL DRIVEWAY

- A. All driveways other than residential driveways shall be commercial driveways conforming to standard drawings.
- B. Street type entrance shall be used on large commercial, industrial, mobile home parks, large scale housing, schools and where large vehicles are anticipated.
- C. Driveways shall be designed so that the algebraic difference in grades will not exceed 10%. Maximum 14% gradient for areas outside San Bernardino County rights of way is permissible, except as shown on Figure 6-2.
- D. Driveway access will not be approved that will require vehicles to back into the public street, except for single family homes on Local or Collector roads which are not access controlled.

SECTION 6.8 VEHICLE QUEUE REQUIREMENTS

When a development is located adjacent to a public street, the parking facility must have full internal vehicular circulation and storage. Vehicular circulation must be located completely within the property and vehicles within one portion of the development must have access to all other portions without using the adjacent road system.

When a proposed development includes a truck loading operation, and has access to a public street, adequate space must be provided that all truck maneuvering is performed off street. Combined truck loading and through vehicle access should be avoided.

Provision for appropriate vehicular exit queuing should be made at all access drives to a development. At high-volume entrances the internal circulation roads or aisle shall

accommodate in bound traffic surges without forcing traffic to queue back onto the external roadway system. A minimum queuing for at least two vehicles shall be maintained, measured from the right-of-way.

MAJOR HIGHWAY
SECONDARY HIGHWAY

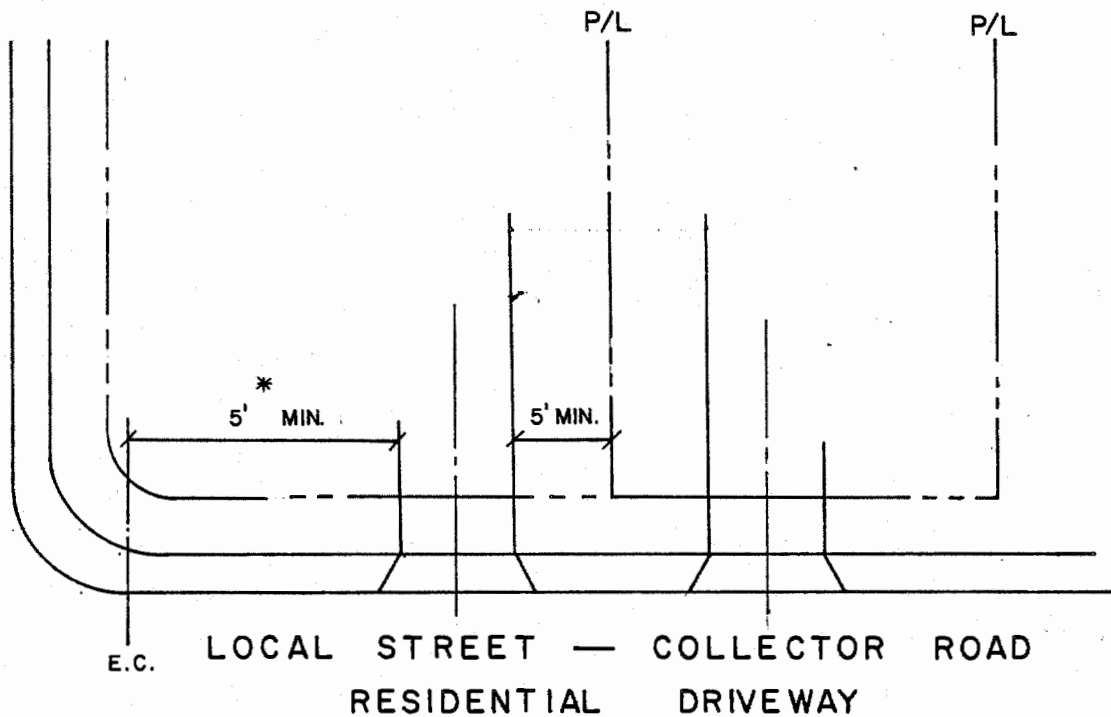

* 75' ON COLLECTOR ROADS, EXCEPT 50' IF ULT. A.D.T. IS LESS THAN 3000

MAJOR HIGHWAY
SECONDARY HIGHWAY

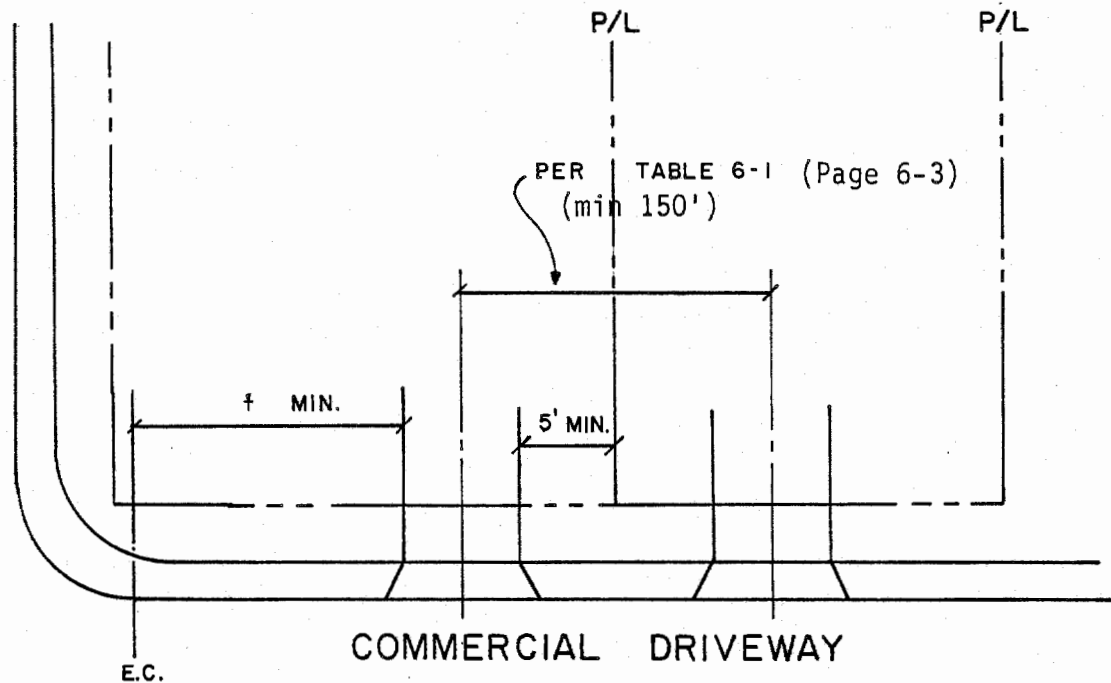

† ON MAJOR OR SECONDARY HIGHWAY 150', MAY BE INCREASED TO PROVIDE ADDITIONAL CLEARANCE FOR LEFT TURN STORAGE
75' ON COLLECTOR ROADS AND 50' ON LOCAL STREETS

Refer to Section 6.3 for number of access points permitted.

SAN BERNARDINO COUNTY TRANS. DEPT.

R.I. 12-21

KEN A. MILLER
Director of Transportation

DRIVEWAY SPACING

FIGURE
6-1

RESIDENTIAL DRIVEWAY

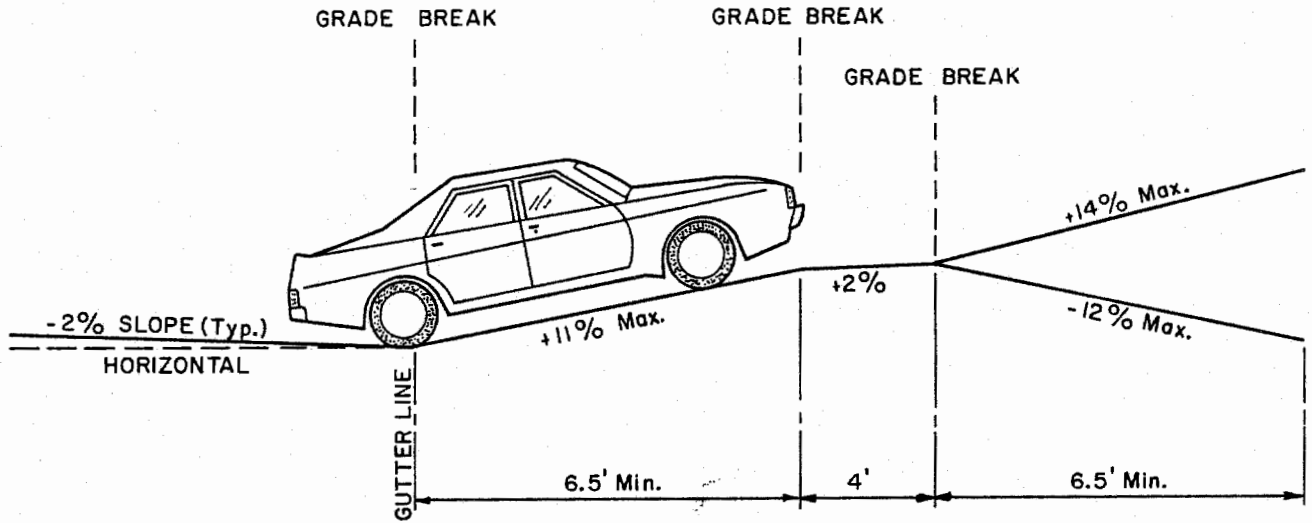

COMMERCIAL DRIVEWAY

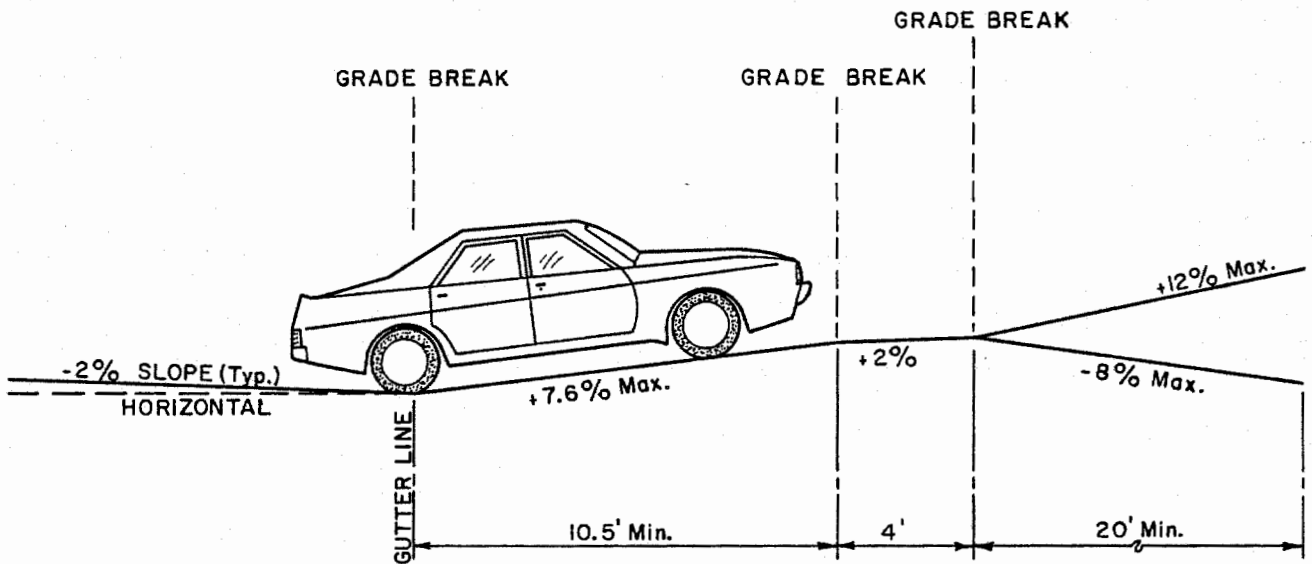

SAN BERNARDINO COUNTY TRANS. DEPT.

KEN A. MILLER
Director of Transportation

DRIVEWAY GRADES

TABLE
6-2

SECTION 6.9 CRITERIA FOR REQUIRING SPEED CHANGE LANES

Speed change lanes will be required according to the following unless a variance is obtained from the Director of Transportation waiving these provisions.

A. Deceleration Lanes for Right Turning Vehicles (Fig. 6-3)

- (1) A speed change lane for right turning deceleration movements is required for any access according to Figure 6-3 when the design hour volumes of the highway (single lane) and the design hour volume of right turns intersect at a point on or above the curve for the posted speed.
- (2) Where the design hour volume of the right turn into the access is less than five and the outside lane volume exceeds 250 on 45 to 55 mph highways, 450 on 35 to 40 mph highways, or 600 on a 25 to 30 mph highway, a right turn lane may be required due to high traffic volumes on the major street or other unique site specific safety considerations.
- (3) When the access volume meets or exceeds 25 design hour volume for highways with speeds of 25 to 40 mph or 20 design hour volume for highways with speeds in excess of 40 mph, a right turn deceleration lane will be required.

B. Acceleration Lanes for Right Turning Vehicles (Fig. 6-4)

- (1) A speed change lane for right turning acceleration movement is required for any access according to Figure 6-4 when the design hour volume of right turns intersect at a point on or above the curve for the posted speed.
- (2) The Director of Transportation may require a right turn acceleration lane for any access where a high traffic volume on the highway and lack of gaps in traffic make use of an acceleration lane necessary for vehicles to enter the highway traffic flow through the use of merging techniques.
- (3) A right turn acceleration lane will not normally be required when the posted speed is less than 35 mph. The Director of Transportation may require an acceleration lane where necessary for public safety and traffic operations based on site specific conditions.

- (4) Where the design hour volume of the right-turn movement out of the access is less than 15 for highways with speeds of 45 to 55 mph and less than 30 for highways with speeds of 40 mph, no acceleration lane will be required unless specifically necessary due to safety considerations.

C. Deceleration Lanes for Left Turning Vehicles (Figure 6-5)

- (1) A speed change lane for left turning movements will be required for any access according to Figure 6-5 when the design hour volumes of the highway (single lane) and the design hour volume of left turns intersect at a point on or above the curve for the posted speed.
- (2) Where the design hour volume of the left turn into the access is less than 12 and the inside lane volume exceeds 250 on 45 to 55 mph highways or 400 on 25 to 40 mph highways, a left turn lane may be required due to the high traffic volumes or other unique site specific safety considerations.
- (3) When the access volume meets or exceeds 30 design hour volumes for 25 to 40 mph highways, or 25 on 45 to 55 mph highways, a left turn deceleration lane is required.

D. Acceleration Lanes for Left Turning Vehicles

- (1) The need for and use of a left turn acceleration lane is site specific. Factors such as highway speed, access volume, nearby access, existing highway auxiliary lanes, traffic control devices, available stopping sight distance, and other topographic and highway design factors are very influential.
- (2) A left turn acceleration lane may also be required when Director of Transportation determines that the lane would be a benefit to highway safety and operation.
- (3) Left turn acceleration lanes are not required where:
 - a. The intersection is signalized; or
 - b. The acceleration lane would interfere with left turn ingress movements to any other access.

E. General Speed Change Lane Criteria

Figures 6-3 through 6-5 assume that trucks exceeding 30,000 pounds gross vehicle weight contribute less than 7% of the total traffic volume. If the access will have a larger percentage of vehicles exceeding 30,000 pounds gross vehicle weight, half the values in Figures 3 through 5 will be used to require speed change lanes in the interest of public safety.

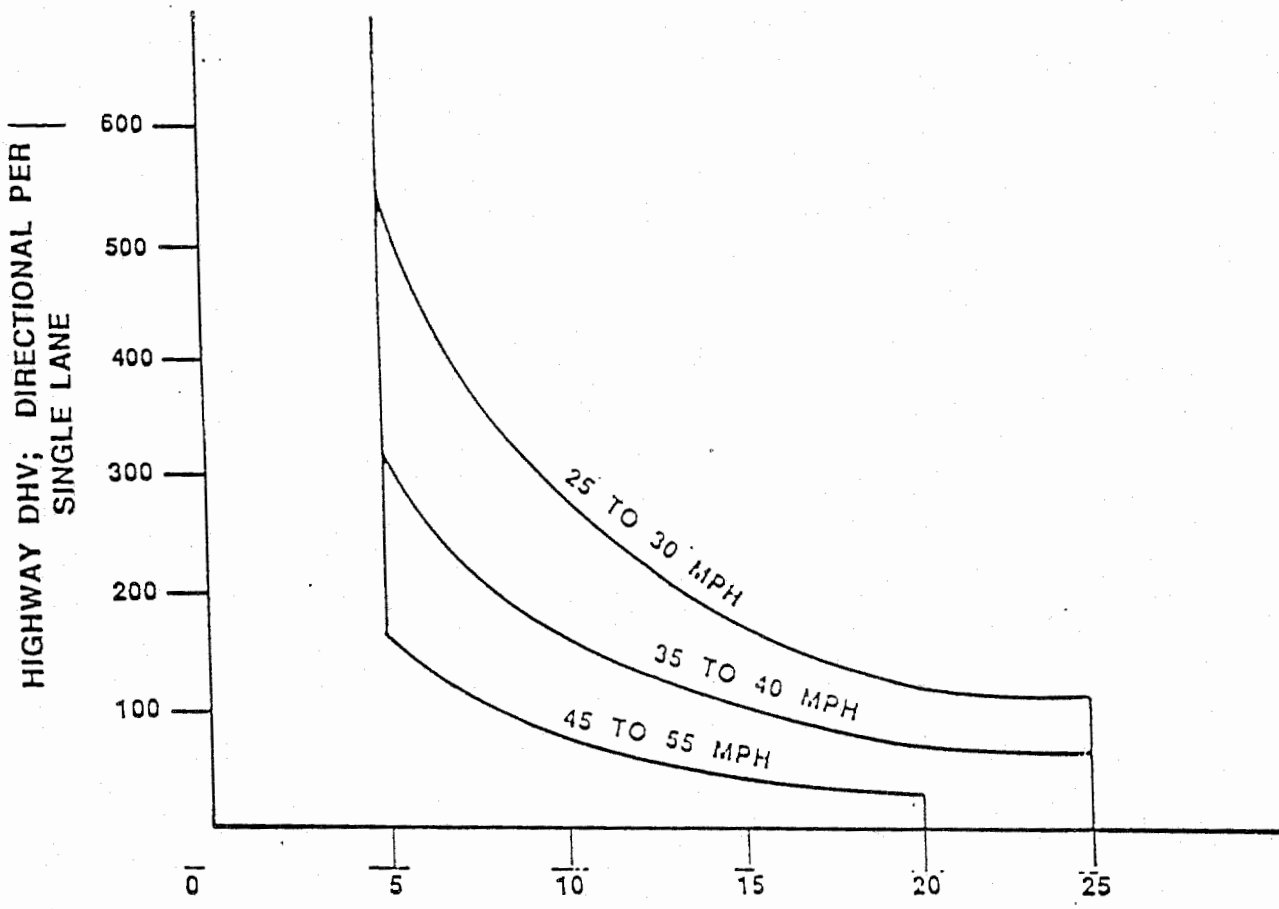

DHV OR AVERAGE PEAK HOUR VOLUME OF VEHICLES TURNING RIGHT INTO ACCESS

Volume Warrants for Right-Turn Deceleration Lanes

FIGURE 6-3

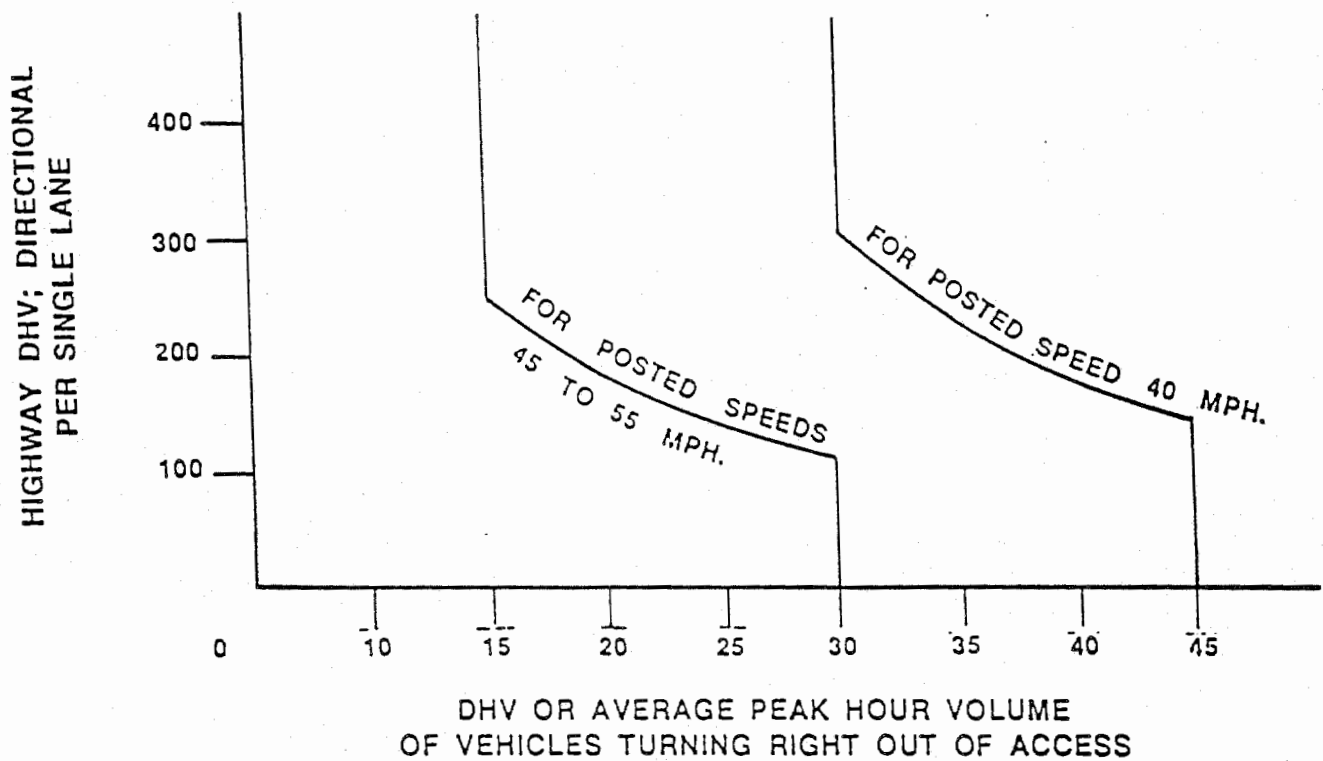

Volume Warrants for Right-Turn Acceleration Lanes

FIGURE 6-4

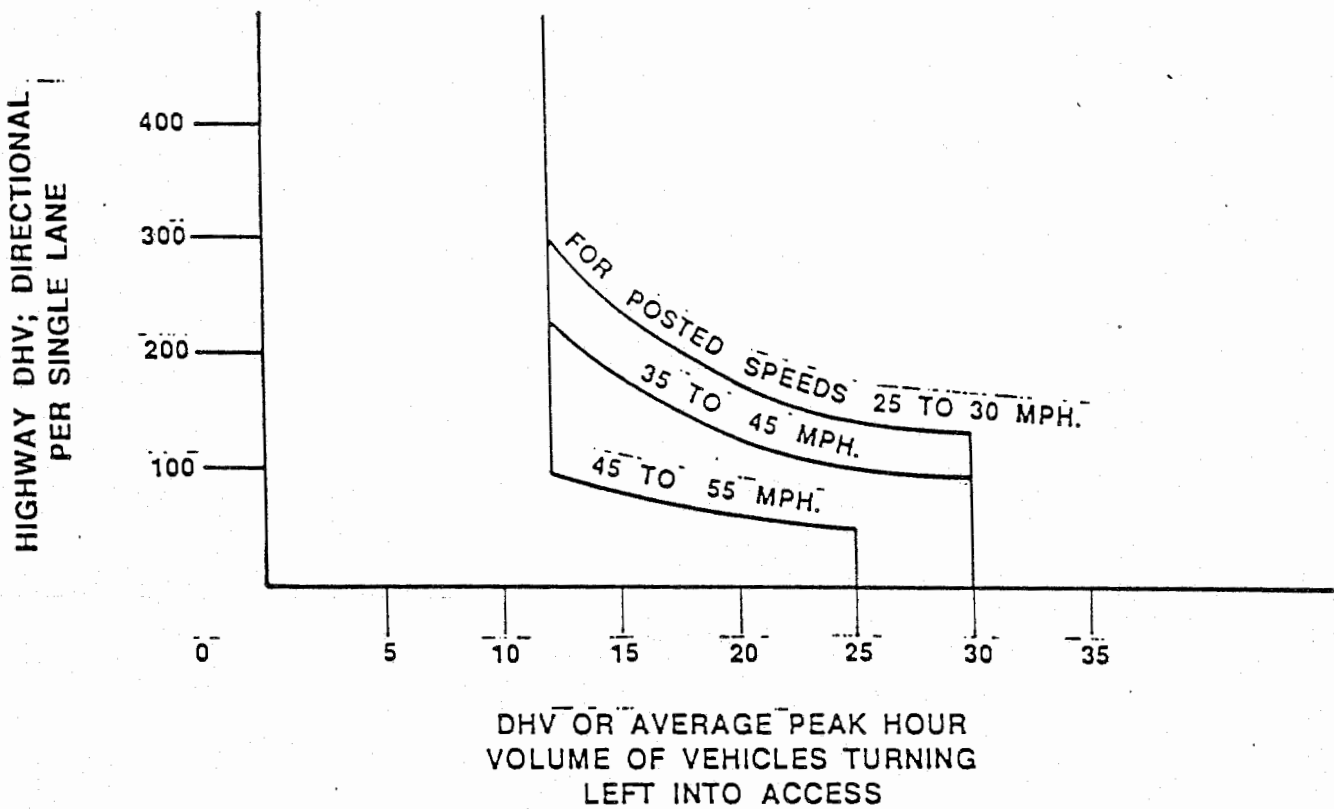

Volume Warrants For Left-Turn Deceleration Lanes

FIGURE 6-5

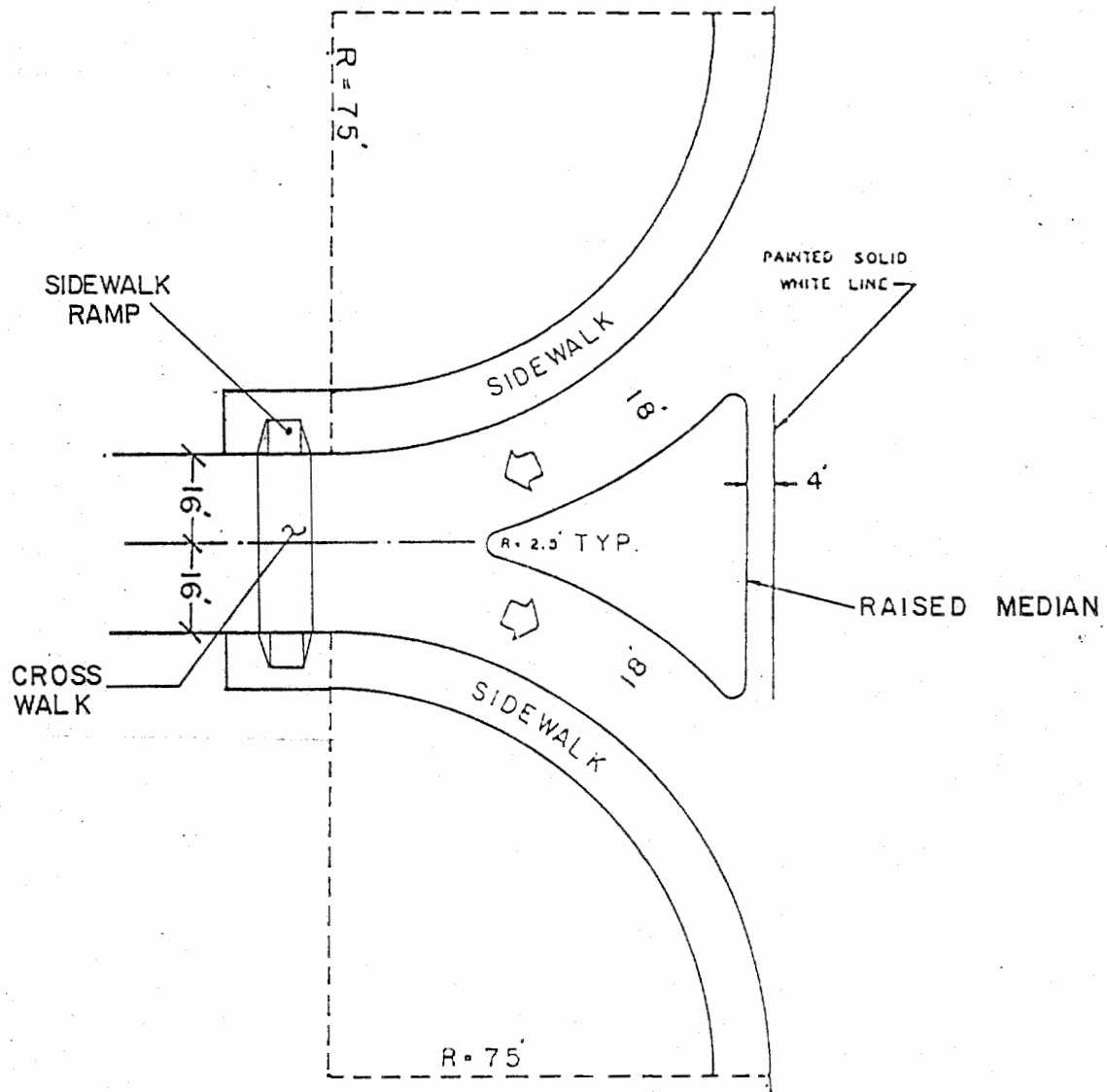

SAN BERNARDINO COUNTY TRANS. DEPT.

R.I. 4-92

KEN A. MILLER
 Director of Transportation

RIGHT IN - RIGHT OUT
 ACCESS DESIGN

FIGURE

6-6

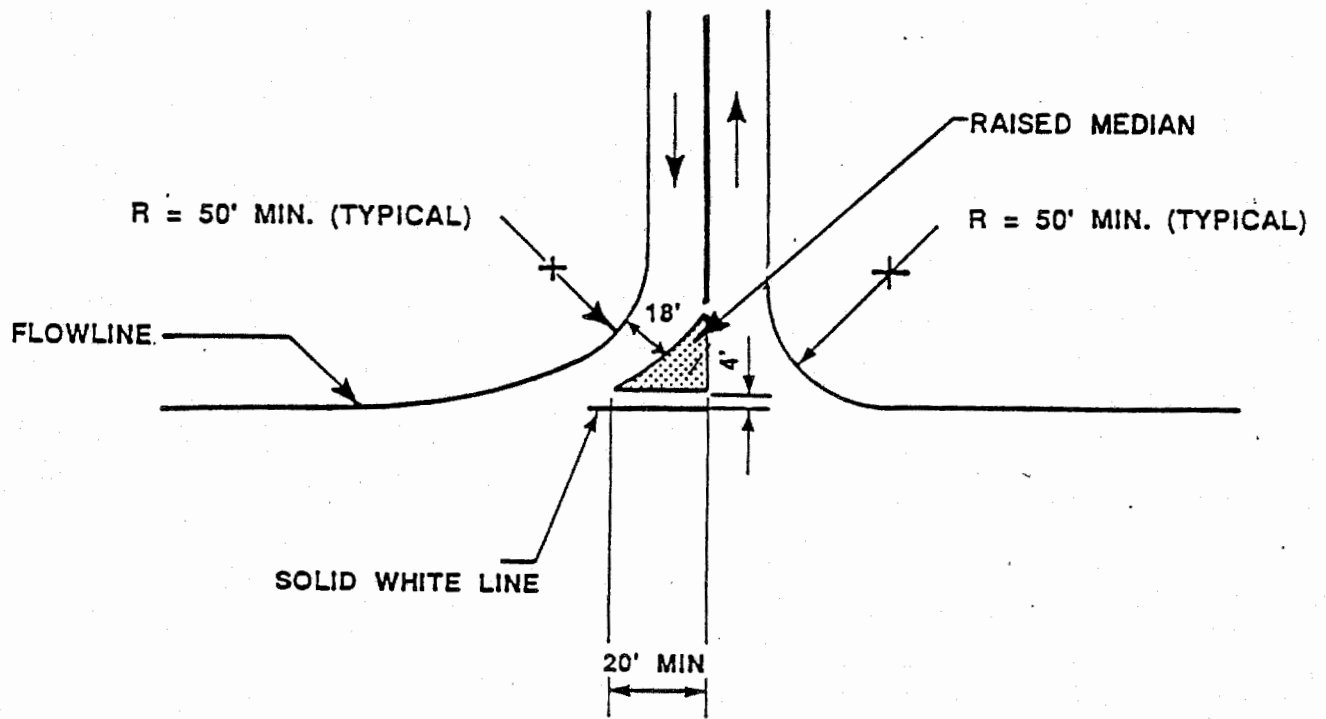

Right-In, Right-Out, Left-In
Access Design

FIGURE
6-7

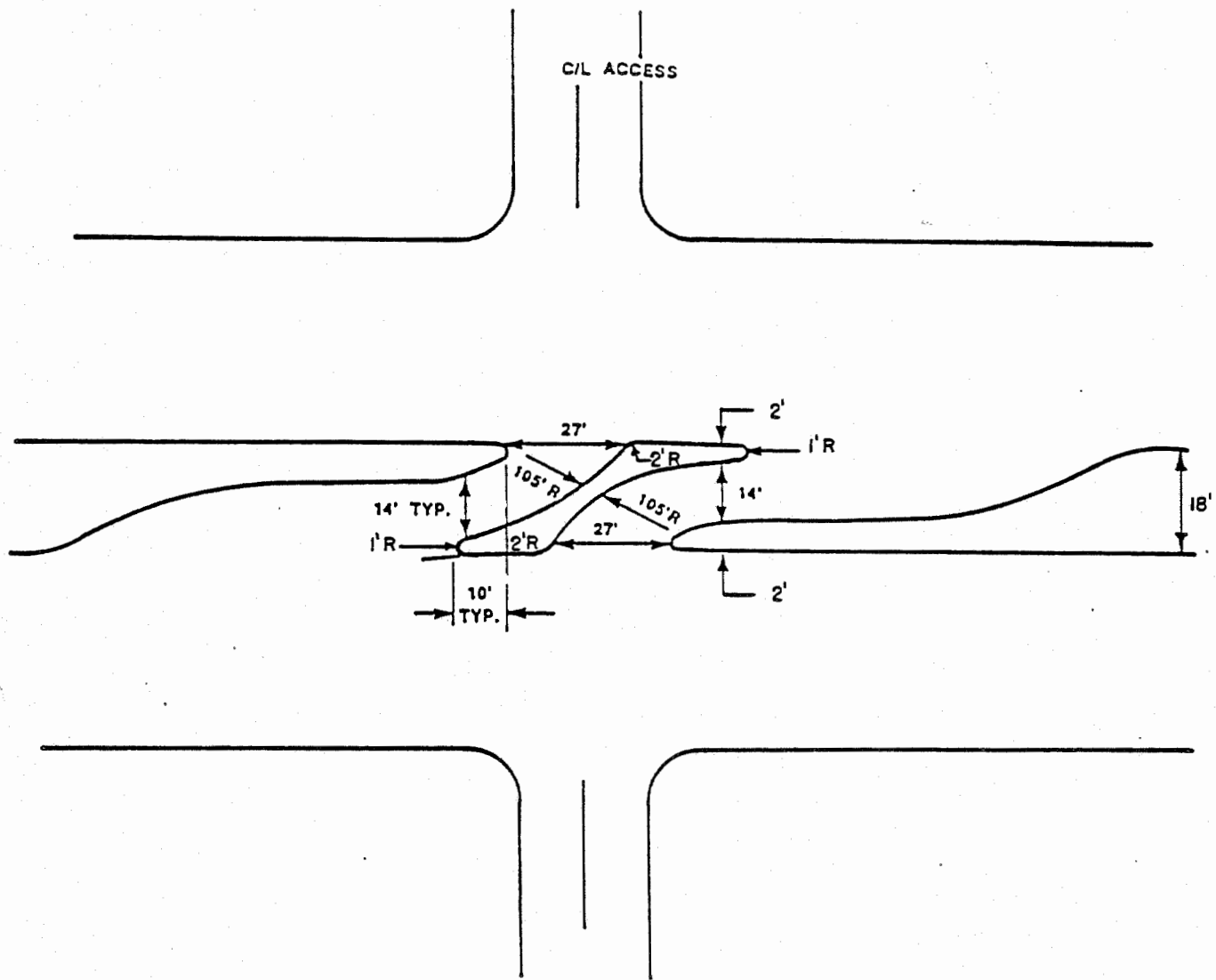

Right-In, Right-Out, Left-In
Median Design

FIGURE
6-8

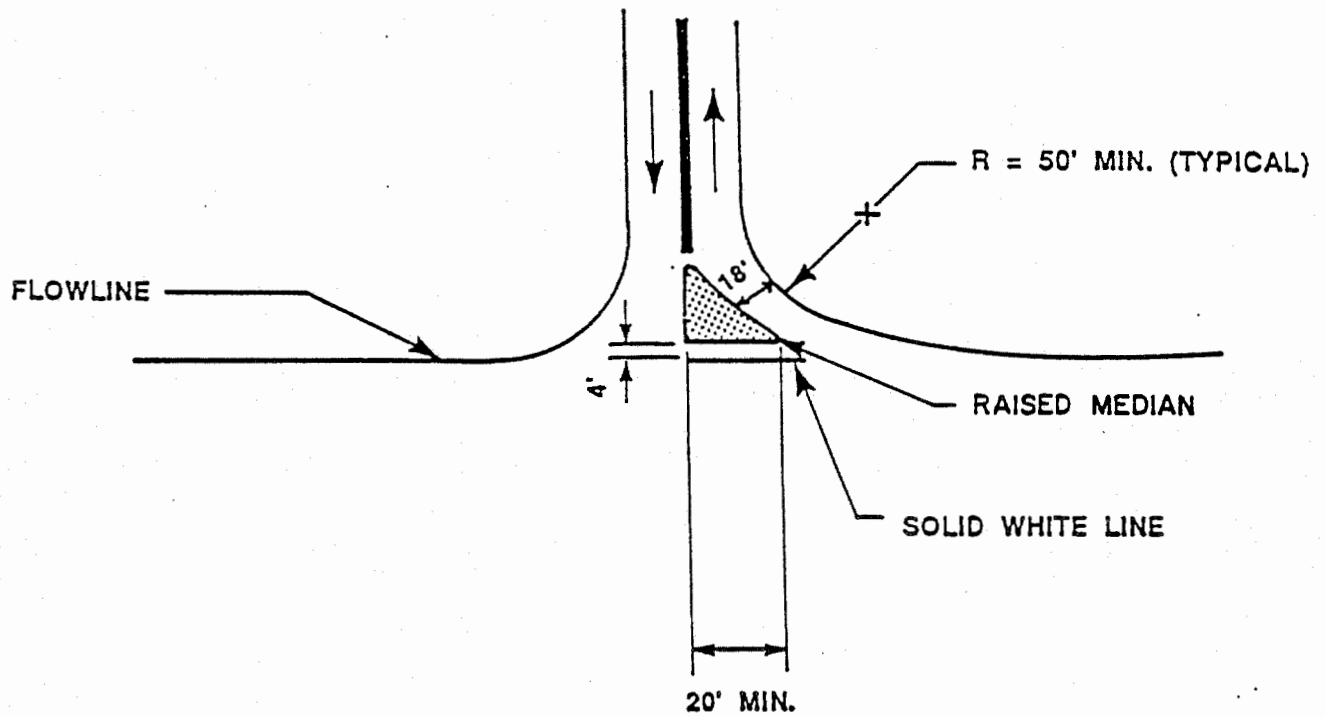

Right-In, Right-Out, Left-Out
Access Design

FIGURE
6-9

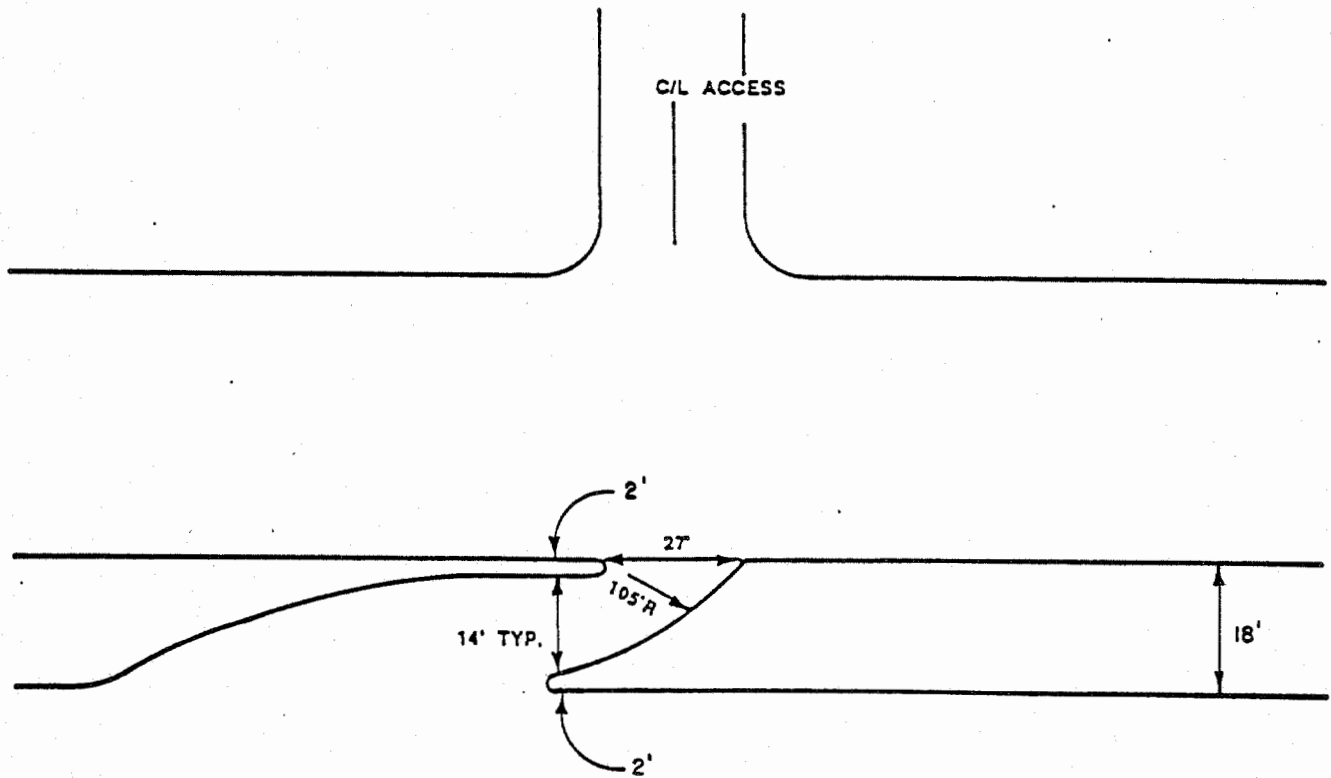

Median Design to Restrict
Exiting Left Turns

FIGURE
6-10

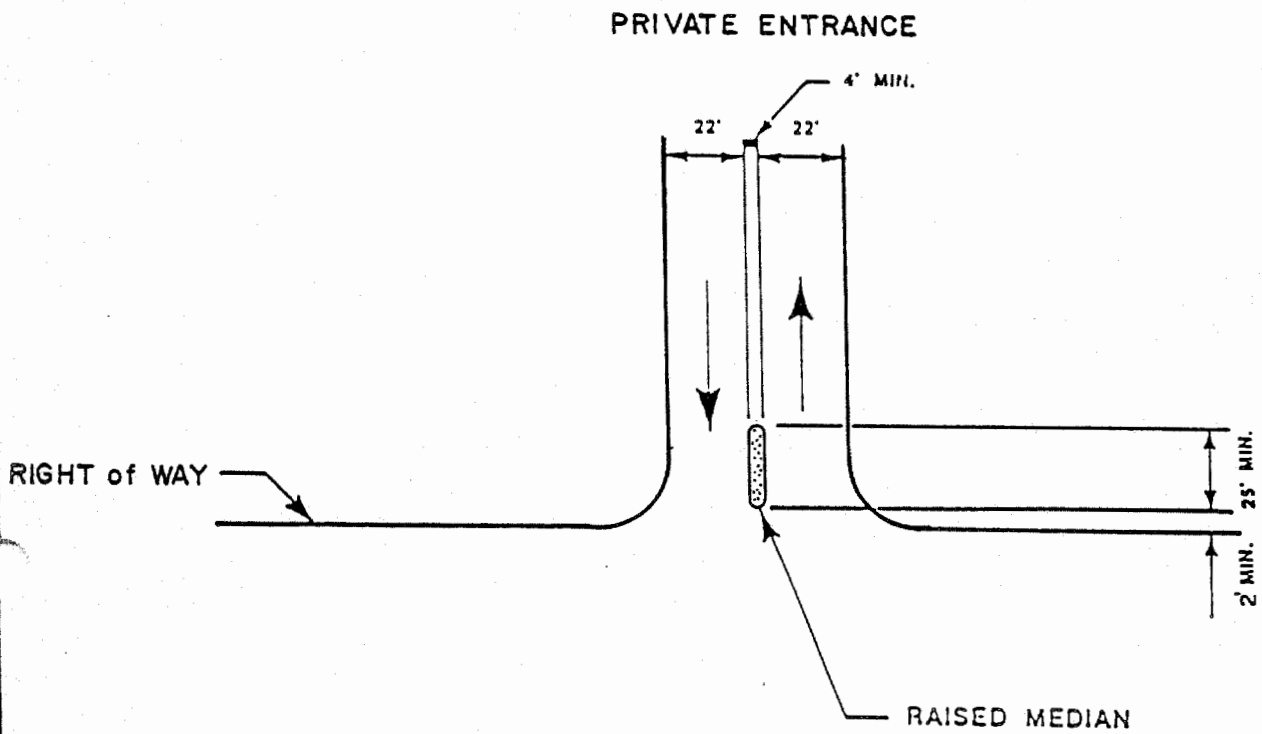

This access design cannot be used for signalized intersection approaches where left-turn lanes have to be aligned.

Access Design with
Median Divider

FIGURE
6-11

ARTICLE VII
DESIGN GUIDELINES

STREET DESIGNATIONS

		LOCAL STREET (>500 ADT)	LOCAL STREET	COLLECTOR	SECONDARY HIGHWAY *	MAJOR HIGHWAY *	MAJOR DIVIDED *	MAJOR ARTERIAL *
RIGHT OF WAY		50	60	66	88	104	120	120
SURFACED WIDTH CURB TO CURB		36	40	44	64	80	94	104
RADII (HORIZ.)	FLAT: 0.5% - 4%	300	470	820	1400	2200	-	-
	ROLLING: 4% - 9%	180	300	470	1100	1800	-	-
MAX. GRADE	FLAT	4	4	4	4	4	-	-
	ROLLING	9	9	8	7	6	-	-
DESIGN SPEED (MIN.)	FLAT	30	35	40	50	60	-	-
	ROLLING	25	30	35	45	55	-	-
INTERSECTION INTERVALS (a) (MIN.)		200	250	660	1320	2640	-	-

NOTES:

1. Minimum street grade 0.5%.
 2. Roadway design less than shown requires Transportation Department approval.
 3. Part-width streets shall have a minimum of 40' R/W and 26' paving for residential and 50' R/W and 36' paving for industrial.
 4. Radii based on "Geometric Design of Highways and Streets" for speeds 35 MPH or less (-2% super elevation). Radii based on Caltrans "Comfortable Speed" for speeds 40 MPH or more (-2% elevation).
- * Direct vehicular access restricted.
- (a) Additional distance may be required when left turns are necessary or when directed by Director of Transportation.

SAN BERNARDINO COUNTY TRANS. DEPT.		VALLEY DESIGN GUIDELINES	TABLE 7-1
KEN A. MILLER Director of Transportation			

STREET DESIGNATIONS

		LOCAL STREET (>500 ADT)	LOCAL STREET	COLLECTOR	SECONDARY HIGHWAY *	MAJOR HIGHWAY *	MAJOR DIVIDED *	MAJOR ARTERIAL *
RIGHT OF WAY		50	60	66	88	104	120	120
SURFACED WIDTH CURB TO CURB		36	40	44	64	80	94	104
RADII (HORIZ.)	FLAT: 0.5% - 4%	300	470	1100	1800	2200	-	-
	ROLLING: 4% - 9%	180	300	470	1100	1800	-	-
MAX. GRADE	FLAT	4	4	4	4	3	-	-
	ROLLING	9	9	8	6	6	-	-
DESIGN SPEED (MIN.)	FLAT	30	35	45	55	60	-	-
	ROLLING	25	30	35	45	55	-	-
INTERSECTION INTERVALS (a) (MIN.)		200	250	660	1320	2640	-	-

NOTES:

1. Minimum street grade 0.5%.
 2. Roadway design less than shown requires Transportation Department approval.
 3. Part-width streets shall have a minimum of 40' R/W and 26' paving for residential and 50' R/W and 36' paving for industrial.
 4. Radii based on "Geometric Design of Highways and Streets" for speeds 35 MPH or less (-2% super elevation). Radii based on Caltrans "Comfortable Speed" for speeds 40 MPH or more (-2% elevation).
- * Direct vehicular access restricted.
- (a) Additional distance may be required when left turns are necessary or when directed by Director of Transportation.

SAN BERNARDINO COUNTY TRANS. DEPT.		DESERT DESIGN GUIDELINES	TABLE 7-2
	KEN A. MILLER Director of Transportation		

STREET DESIGNATIONS

		MOUNTAIN LOCAL	MOUNTAIN SECONDARY HW	MOUNTAIN * MAJOR HWY	MOUNTAIN * EXPRESSWAY
RIGHT OF WAY		40	60	80	104
SURACED WIDTH CURB TO CURB (DIKE)		26	44	64	80
RADII (HORIZ.)	FLAT: 0.5% - 4.0%	300	470	820	1100
	ROLLING: 4.0% - 9.0%	180	300	470	820
	MOUNTAINOUS 9.0% - 12.0%	100	180	300	470
MAX. GRADE	FLAT	4	4	4	3
	ROLLING	9	8	7	6
	MOUNTAINOUS	12 [▲]	12 [▲]	9	8
MIN. DESIGN SPEED	FLAT	30	35	40	45
	ROLLING	25	30	35	40
	MOUNTAINOUS	20	25	30	35

NOTES:

1. Minimum street grade 0.5%.
 2. Roadway design less than shown requires Transportation Department approval.
 3. Part-width streets shall have a minimum of 40' R/W and 26' paving for residential and 50' R/W and 36' paving for industrial.
 4. Radii based on "Geometric Design of Highways and Streets" for speeds 35 MPH or less (-2% super elevation). Radii based on Caltrans "Comfortable Speed" for speeds 40 MPH or more (-2% elevation).
- * Direct vehicular access restricted.
 ▲ 14% maximum for short segments not to exceed 500 feet.

SAN BERNARDINO COUNTY TRANS. DEPT.		MOUNTAIN DESIGN GUIDELINES	TABLE 7 - 3
KEN A. MILLER Director of Transportation			

ARTICLE VIII
GEOMETRIC DESIGN STANDARDS

SECTION 8.1 INTERSECTION OBJECTIVES

The main objective of intersection designs is to minimize potential conflicts between vehicles, bicycles and pedestrians while providing convenience, safety and comfort to the general public. Four basic elements should be considered in designing intersections: human factors, traffic capacity considerations, physical characteristics and economic factors.

SECTION 8.2 CAPACITY ANALYSIS

The capacity analysis is one of the most important considerations in the design of intersections. This analysis is discussed in Article X "Traffic Studies".

SECTION 8.3 INTERSECTION ALIGNMENT

On major street intersections, the street centerline alignment should be designed in accordance with Table 7-1 through 7-3. The offset distance may need to be increased if left turn lanes are being proposed. When two local streets intersect each other, a Tee "T" intersection design is preferred, rather than a four way intersection. The street center lines should be at 90 degrees with each other, however a deviation not to exceed ten (10) degrees is acceptable, when determined by the Director of Transportation necessary due to terrain or right-of-way restrictions. Streets should intersect on the outside of a horizontal curve and on the crest of the vertical curve.

Horizontal curves near intersections should be avoided on Secondary and Major Highways. When horizontal curves are proposed on Local or Collector Streets near intersections, the curve should terminate a minimum of thirty (30) feet from the curb return.

SECTION 8.4 CLEAR SIGHT TRIANGLE (Figure 8-1)

Adequate visibility for vehicular and pedestrian traffic shall be provided at all intersections. At the clear sight triangle, Figure 8-1, there shall be no sight obstructions such as walls, fencing, monument signs, except traffic devices, signs or no more than two (2) posts or columns each with a width no greater than twelve (12) inches. The lower portion of the signs shall provide a minimum of eight (8) feet high clearance. Berming, landscaping or other obstructions within the triangle shall not exceed thirty (30) inches in height, measured from the flowline of the two streets or if no gutter exists, measure from the edge of the traveled way.

SECTION 8.5 STOPPING SIGHT DISTANCE

Stopping sight distance is the available distance necessary for a vehicle traveling at design speed to stop before reaching a stationary object in its path.

For stopping distance calculations, the height of the driver's eye is considered to be 3.50 feet above the road surface and the height of the object is considered to be six (6) inches above the road surface. Figure 8-3.

SECTION 8.6 INTERSECTION SIGHT DISTANCE

Intersections contain several potential vehicle conflicts which need to be considered. Figure 8-2 and Figure 8-3 provide acceptable design for passenger vehicle at intersections. When the road grades are other than flat or heavy vehicles are encountered, corrections should be made to the sight distance shown on Figure 8-3.

In determining whether the sight distance is adequate at an intersection, the sight distance should be measured from a height of eye of 3.50 feet (6.0 feet for tractor semi trailers) to the top of an object 4.25 feet above the pavement.

All intersections shall conform to the requirements of "Clear Sight Triangle", "Stopping Sight Distance" and "Intersection Sight Distance". The most restrictive sight distance shall apply.

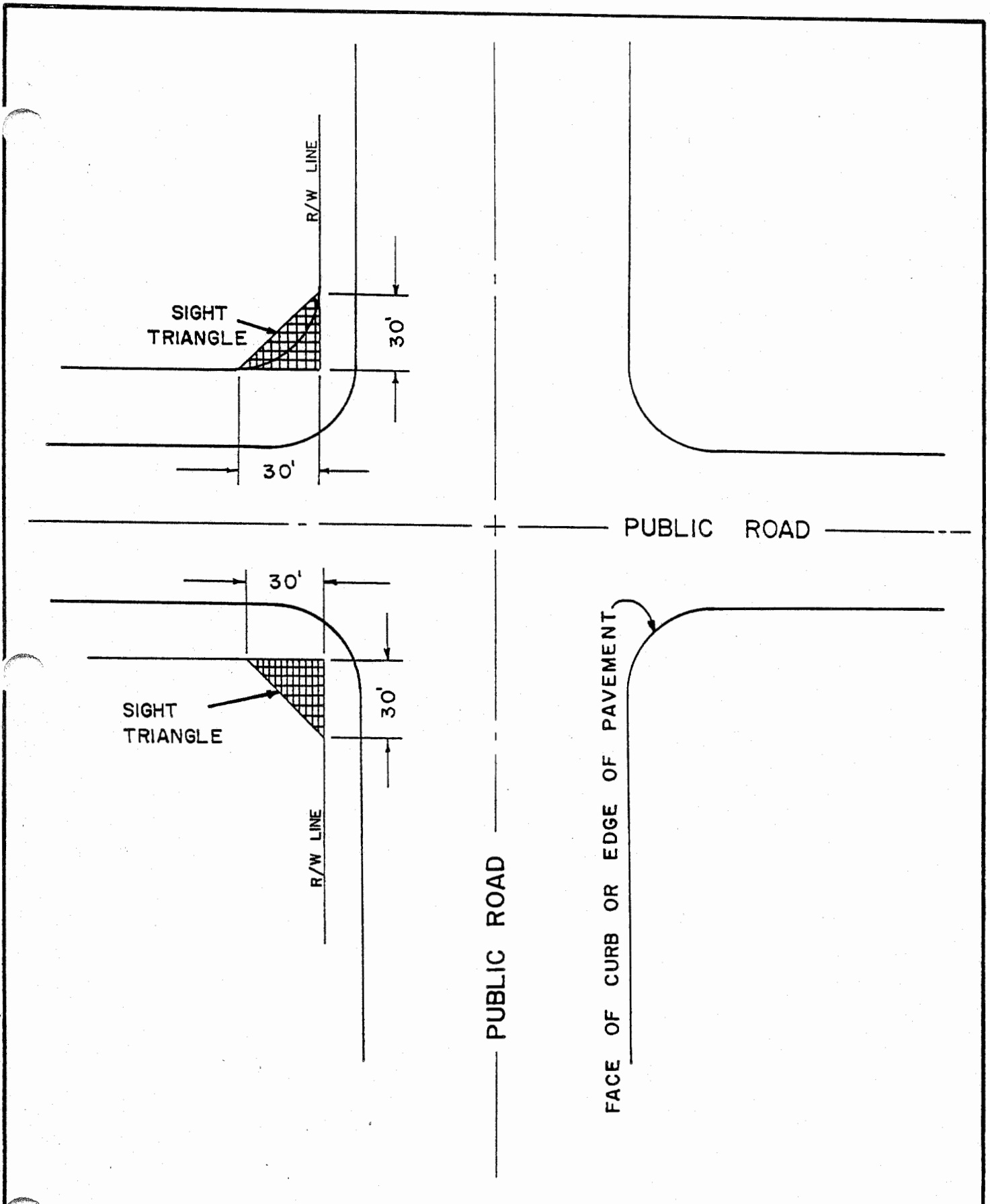

AN BERNARDINO COUNTY TRANS. DEPT.

CLEAR SIGHT TRIANGLE

FIGURE 8-1

At-Grade Intersections

CASE III STOP CONTROL

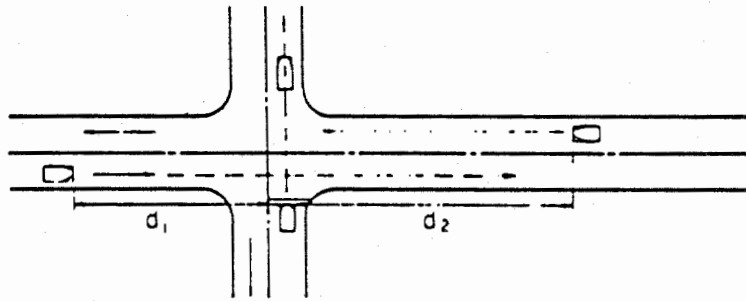

CASE III - A

STOPPED VEHICLE CROSSING A MAJOR HIGHWAY

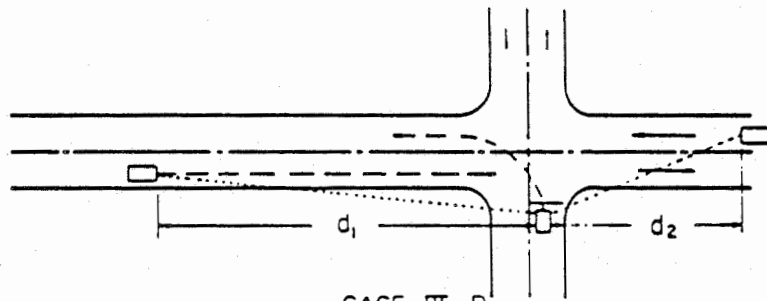

CASE III - B

STOPPED VEHICLE TURNING LEFT ONTO TWO LANE MAJOR HIGHWAY

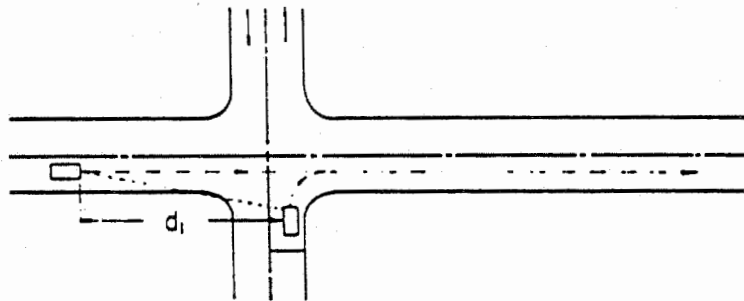

CASE III - C

STOPPED VEHICLE TURNING RIGHT ONTO TWO LANE MAJOR HIGHWAY OR RIGHT TURN ON A RED SIGNAL

* d = Sight Distance

Figure 8-2 Intersection sight distance at at-grade intersections.

- CASE III A**
 A- SAFE SIGHT DISTANCE FOR P VEHICLE CROSSING 2-LANE HIGHWAY FROM STOP. (SEE DIAGRAM)
- CASE III B**
 B-1- SAFE SIGHT DISTANCE FOR P VEHICLE TURNING LEFT INTO 2-LANE HIGHWAY ACROSS P VEHICLE APPROACHING FROM LEFT (SEE DIAGRAM)
- CASE III B**
 B-2a- SAFE SIGHT DISTANCE FOR P VEHICLE TO TURN LEFT INTO 2-LANE HIGHWAY AND ATTAIN DESIGN SPEED WITHOUT BEING OVERTAKEN BY A VEHICLE APPROACHING FROM THE RIGHT AND MAINTAINING DESIGN SPEED
- CASE III B**
 B-2b- SAFE SIGHT DISTANCE FOR P VEHICLE TO TURN LEFT INTO 2-LANE HIGHWAY AND ATTAIN AVERAGE RUNNING SPEED WITHOUT BEING OVERTAKEN BY VEHICLE APPROACHING FROM THE RIGHT REDUCING SPEED FROM DESIGN SPEED TO AVERAGE RUNNING SPEED. (SEE DIAGRAM)
- CASE III C**
 C-1- SAFE SIGHT DISTANCE TO P VEHICLE TO TURN RIGHT INTO A 2-LANE HIGHWAY AND ATTAIN DESIGN SPEED WITHOUT BEING OVERTAKEN BY A P VEHICLE APPROACHING FROM THE LEFT TRAVELING AT DESIGN SPEED
- CASE III C**
 C-2- SAFE SIGHT DISTANCE FOR P VEHICLE TO TURN RIGHT INTO 2-LANE HIGHWAY AND ATTAIN AVERAGE RUNNING SPEED WITHOUT BEING OVERTAKEN BY VEHICLE APPROACHING FROM THE LEFT AND REDUCING FROM DESIGN SPEED TO AVERAGE RUNNING SPEED

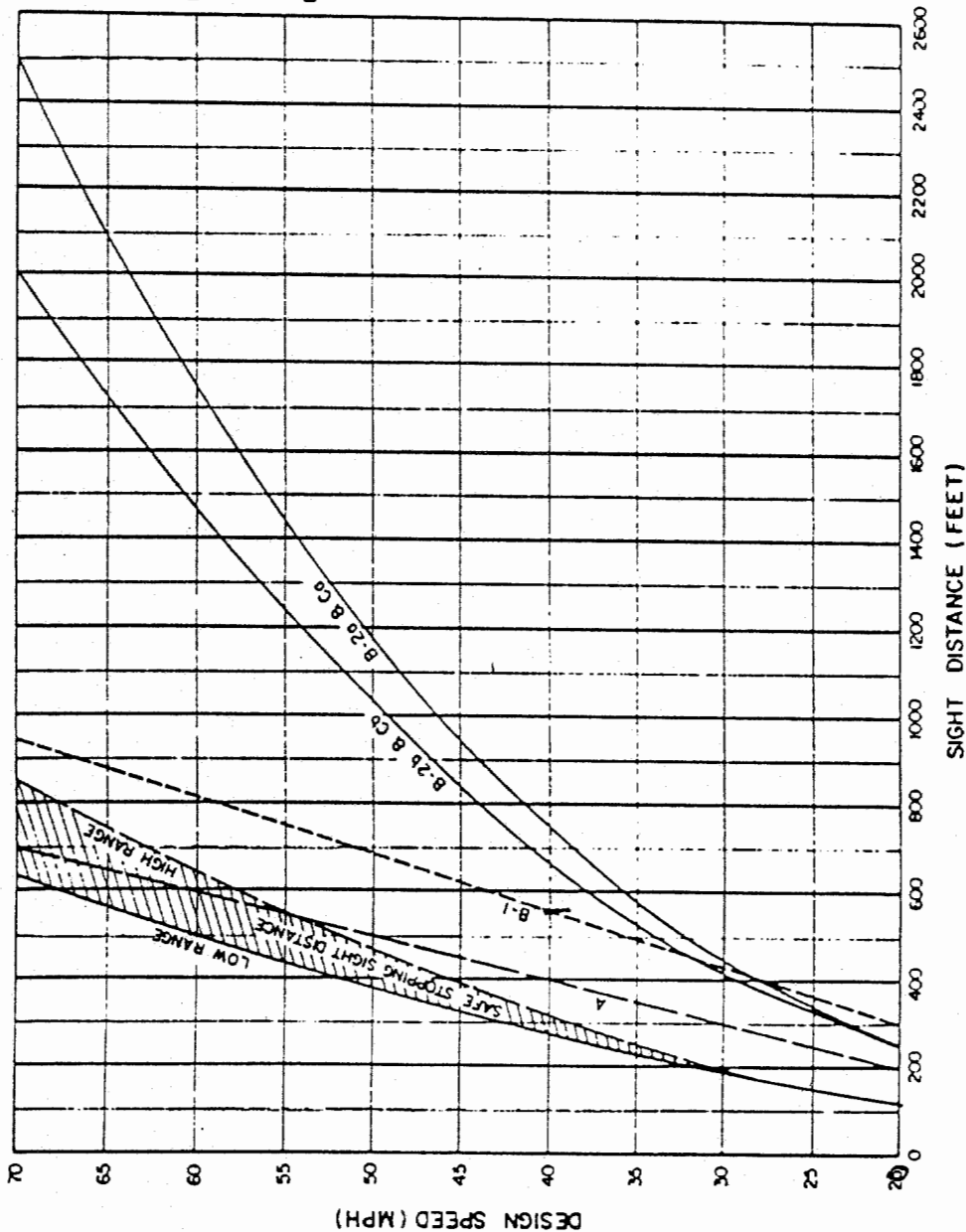

Figure 8-3 Intersection sight distance at at-grade intersection (case IIB and case IIIC).

EFFECT OF GRADE ON STOPPING SIGHT DISTANCE

Design Speed (mph)	Increase for Downgrades			Decrease for Upgrades			
	Correction in Stopping Distance (ft)			Assumed Speed for Condition (mph)	Correction in Stopping Distance (ft)		
	3%	6%	9%		3%	6%	9%
30	10	20	30	28	—	10	20
40	20	40	70	36	10	20	30
50	30	70	—	44	20	30	—
60	50	110	—	52	30	50	—
65	60	130	—	55	30	60	—
70	70	160	—	58	40	70	—

Table 8-1 Effect of grade on stopping sight distance—wet conditions.

Source: "AASHTO"

SECTION 8.7 CHANNELIZATION

Potential vehicle and pedestrian conflicts may be reduced through channelization of traffic movements. Channelization can be used to separate and direct traffic to their intended route. The confusing traffic movements resulting from too spacious paved areas may be eliminated by conversion of the normally unused areas into islands that leave little to the discretion of drivers.

Channelizing should be placed so that the proper course of travel is obvious, easy to follow, and of unquestionable continuity.

The use of curbed islands generally should be reserved for multilane highways with ADT in excess of 25,000 ADT and for the more important intersections on two-lane highways. Curbed islands are sometimes difficult to see at night. Accordingly, where curbed islands are used, the intersection should have fixed-source lighting or appropriate delineation.

The designer should refer to the current Caltrans Highway Design Manual for channelization of intersections.

Left-turn lanes are provided to accommodate heavy left turn movements without disruption to through vehicle movements and allows for the use of a protected storage for queued left-turn vehicles. Where space permits, the use of left-turn lane should be considered where left-turn volumes exceed 100 vph. Left-turn lanes may be provided for lower volumes as well, based on public safety needs and as directed by the Director of Transportation.

A. Left-turn storage for signalized intersections

A single left-turn storage design of signalized intersection can be determined from Figure 8-8A. This figure can be used to estimate the storage length (excluding taper) of a double left-turn bay by dividing by 1.8. A double left-turn design should be considered when left-turn volumes exceed 300 vph.

B. Left-turn storage for unsignalized intersections for four lane roadways.

A single left turn storage design for four lane unsignalized intersection can be determined from Figure 8-8B. The opposing volumes include only through volumes opposing the left turn movement on the same street for which the left turn channel is being designed.

On roads with one travel lane in each direction, the left turn storage can be estimated to be twice the requirement for a four-lane highway as indicated on Figure 8-8B.

Figure 8-4

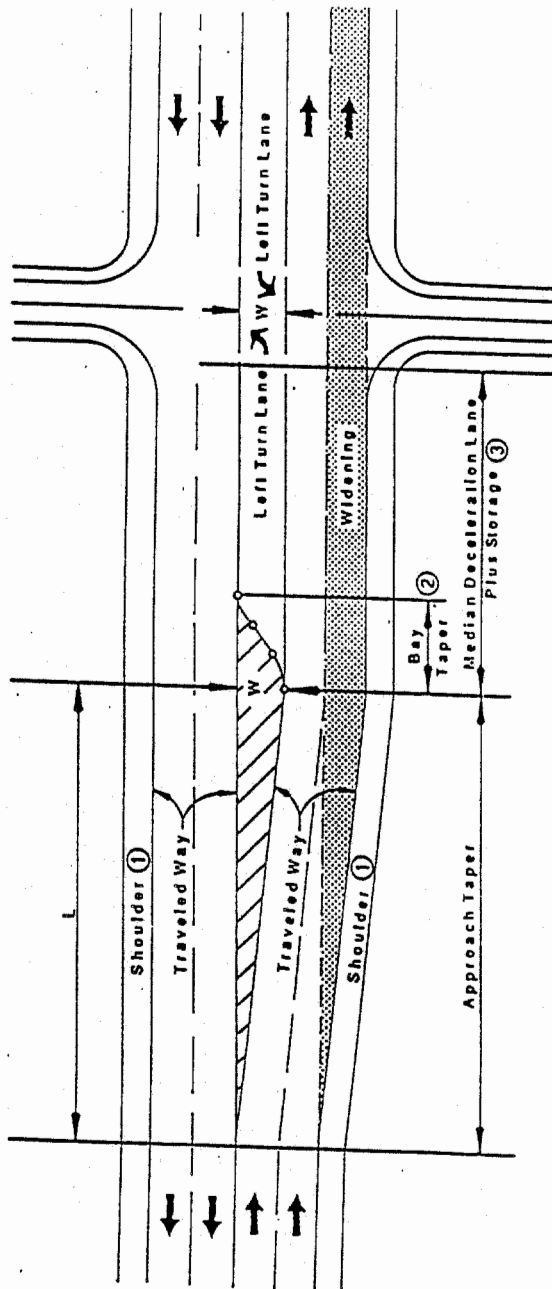

EQUATION: $L = \frac{V^2 W}{60}$ ④

Where L - Length of Approach Taper - Feet
 V - Design Speed - MPH
 W - Width of Median Lane - Feet

NOTES:

- ① Where width is restricted, shoulder width may be reduced and parking restricted. For bicycle use, a minimum 4' shoulder is required.
- ② Bay taper length - 60' to 120'. (See Table 8-3)
- ③ For deceleration lane length see Table 8-2
- ④ Where both sides of roadway are widened, use a fraction of "W" that is proportional to widening on each side.

Standard Left-turn Channelization

Figure 8-5

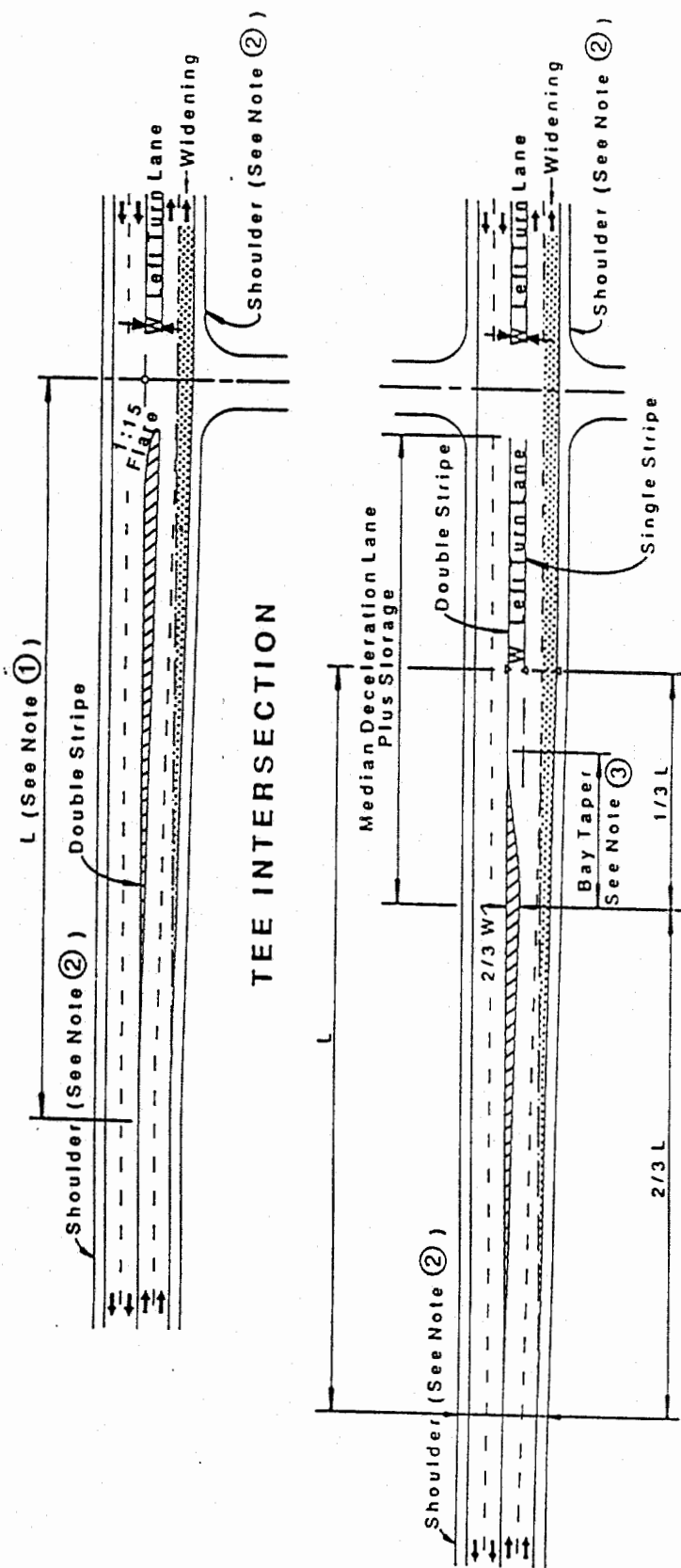

4 - LEG INTERSECTION

EQUATION:

$$L = \frac{V^2 W}{60}$$

Where L = Length of Transition - Feet
 W = Width of Median Lane - Feet
 V = Design Speed - MPH

NOTES:

- ① L = 500' Maximum
- ② Where width is restricted, shoulder width may be reduced and parking restricted. For bicycle use, a minimum 4' shoulder is required.
- ③ Bay taper length 60' to 120' (See Table 8-3)

Minimum Median Left-turn Channelization
 (Widening on One Side of Highway)

Figure 8-6

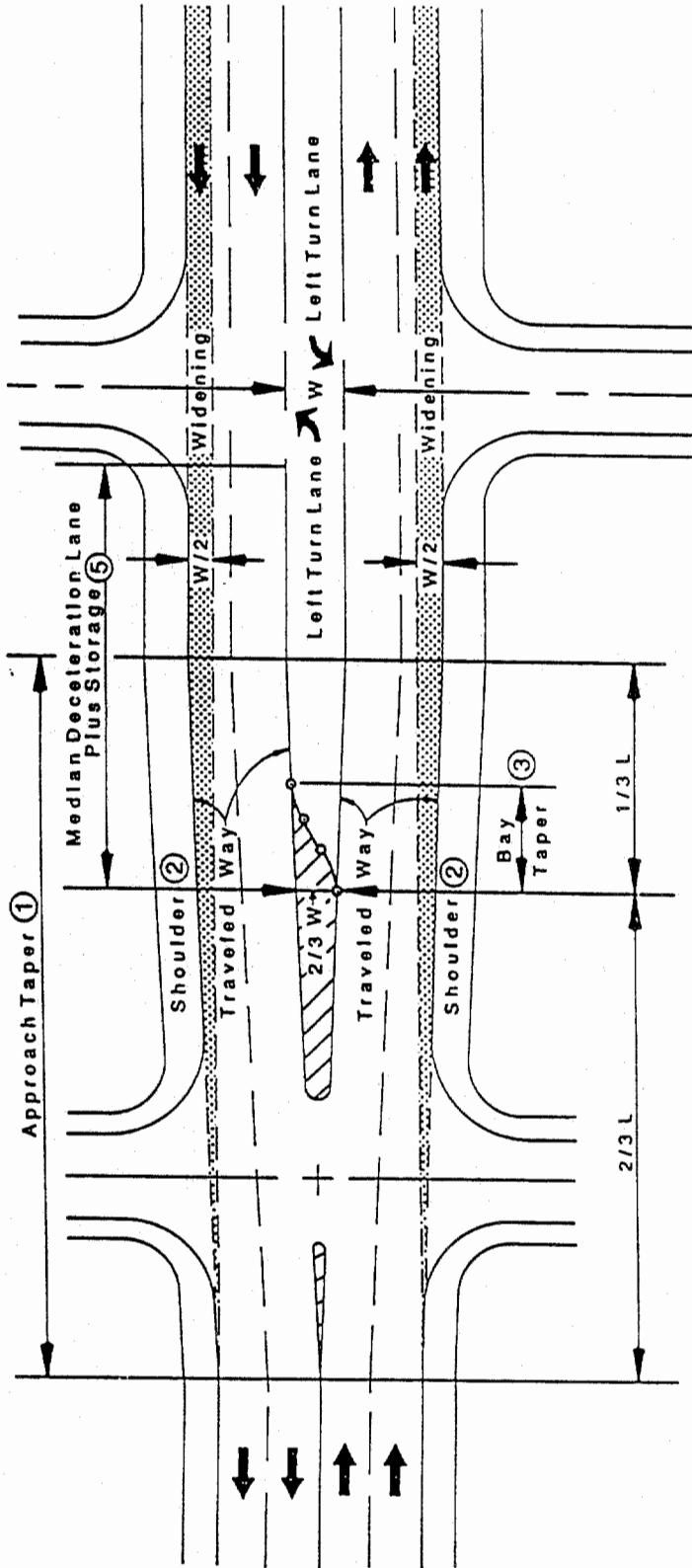

EQUATION: (4)

$$L = \frac{V^2 \left(\frac{W}{2} \right)}{60}$$

Where
 L = Length of Approach Taper - Feet
 W = Width of Median Lane - Feet
 V = Design Speed - MPH

NOTES:

- (1) L = 500' Maximum
- (2) Where width is restricted, shoulder width may be reduced and parking restricted. For bicycle use, a minimum 4' shoulder is required.
- (3) Bay taper length = 60' to 120'. (See Table 8-3)
- (4) Assumes equal widening each side. Where widening is unequal, use a fraction that is proportional to widening on each side.
- (5) For deceleration lane length see Table 8-2

**Minimum Median Left-turn Channelization
 (Widening on Both Sides in Urban Areas with Short Blocks)**

Figure 8-7

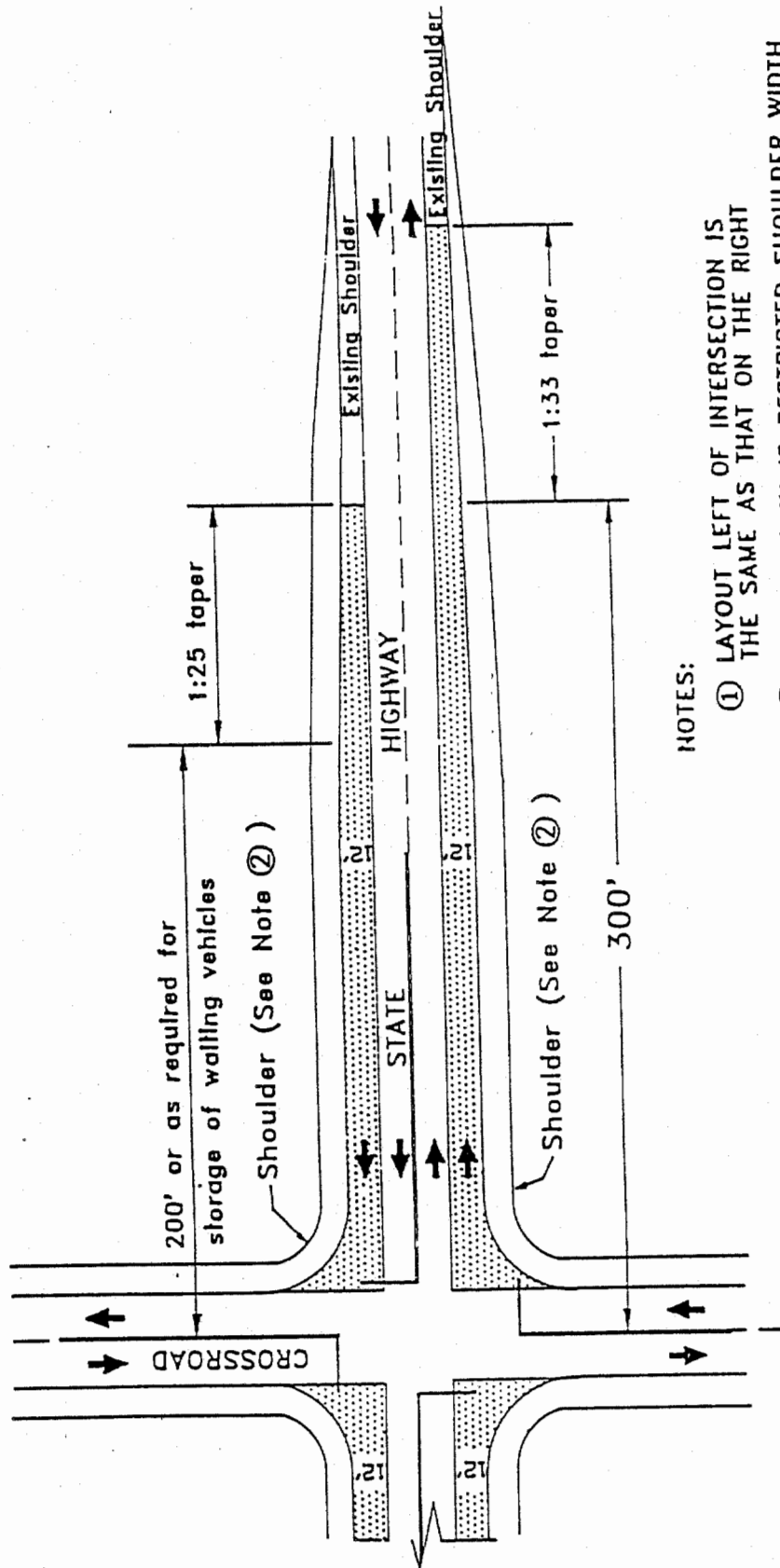

NOTES:

- ① LAYOUT LEFT OF INTERSECTION IS THE SAME AS THAT ON THE RIGHT
- ② WHERE WIDTH IS RESTRICTED SHOULDER WIDTH MAY BE REDUCED AND PARKING RESTRICTED. FOR BICYCLE USE, A MINIMUM 4' SHOULDER IS REQUIRED.

▨ WIDENING

Widening of Two-lane Roads at Signalized Intersections

Table 8-2
Deceleration Lane Length

Design Speed (mph)	Length to Stop (ft)
30	.235
40	.315
50	.435
60	.530

Table 8-3
Bay Taper for Median Speed-change Lanes

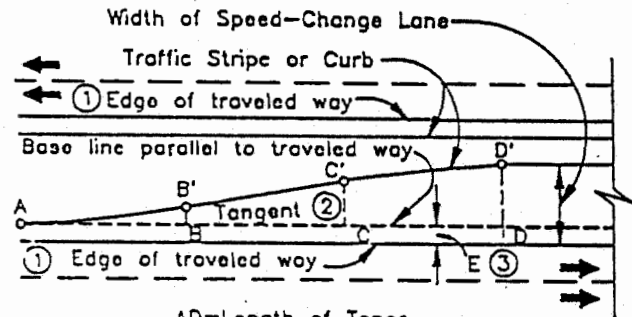

AD=Length of Taper
AB=BC=CD=1/3 AD
A'B' & C'D' are Parabolic Curves

LENGTH OF TAPER - FEET			OFFSET DISTANCE			
60	90	120	DD'= 10'	DD'= 11'	DD'= 12'	
Distance From Point "A"			0	0	0	
5	7.5	10	0.16	0.17	0.19	
10	15	20	0.62	0.69	0.75	
15	22.5	30	1.41	1.55	1.69	
B'	20	30	40	2.50	2.75	3.00
	30	45	60	5.00	5.50	6.00
C'	40	60	80	7.50	8.25	9.00
	45	67.5	90	8.59	9.45	10.31
	50	75	100	9.38	10.31	11.25
	55	82.5	110	9.84	10.83	11.81
	60	90	120	10.0	11.0	12.0

¹The table gives offsets from a base line parallel to the edge of traveled way at intervals measured from point "A". Add "E" for measurements from edge of traveled way.

²Where edge of traveled way is a curve, neither base line nor taper between B & C will be a tangent. Use proportional offsets from B to C.

³The offset "E" is usually 2' along edge of traveled way for curbed medians; Use "E" = 0' for striped medians.

Desirable: 95% probability of storing all left turn vehicles
 Minimum: 90% probability

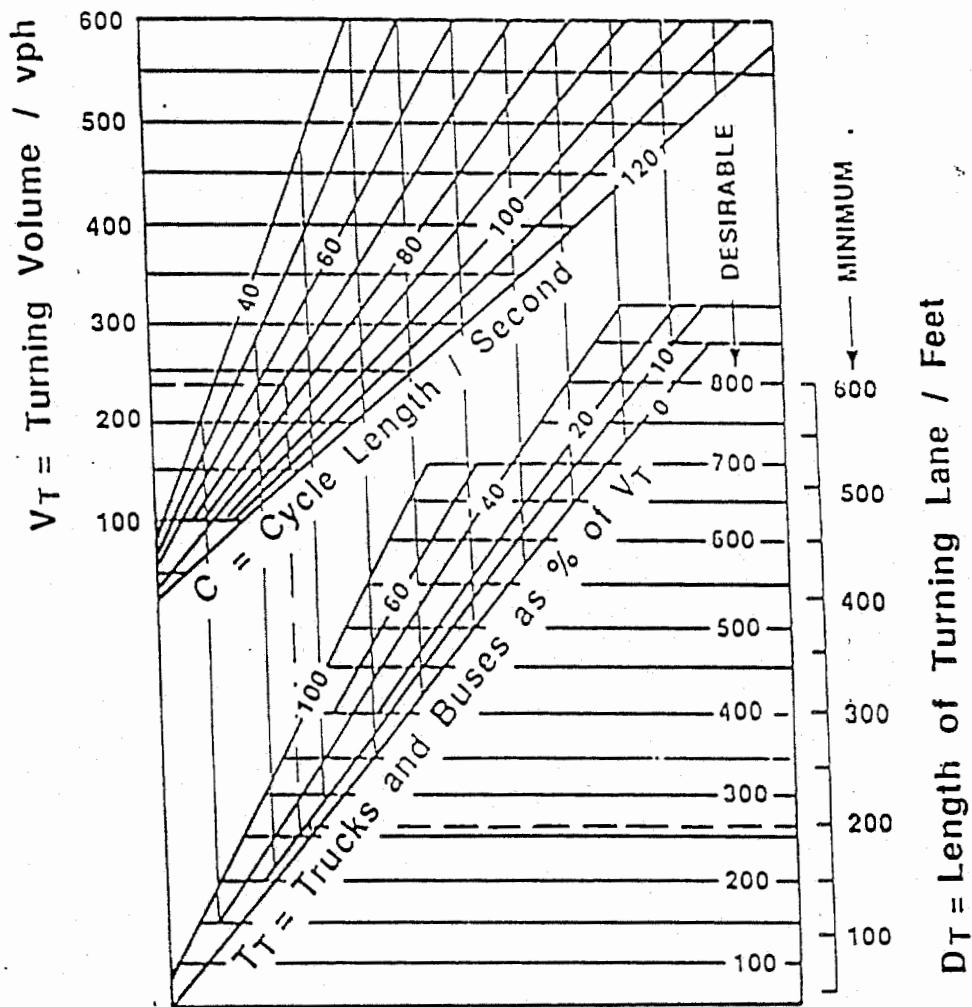

Design of Left Turn Storage Length
 Volume-Based Nomograph for
 At-Grade Signalized Intersections

FIGURE
 8-8A

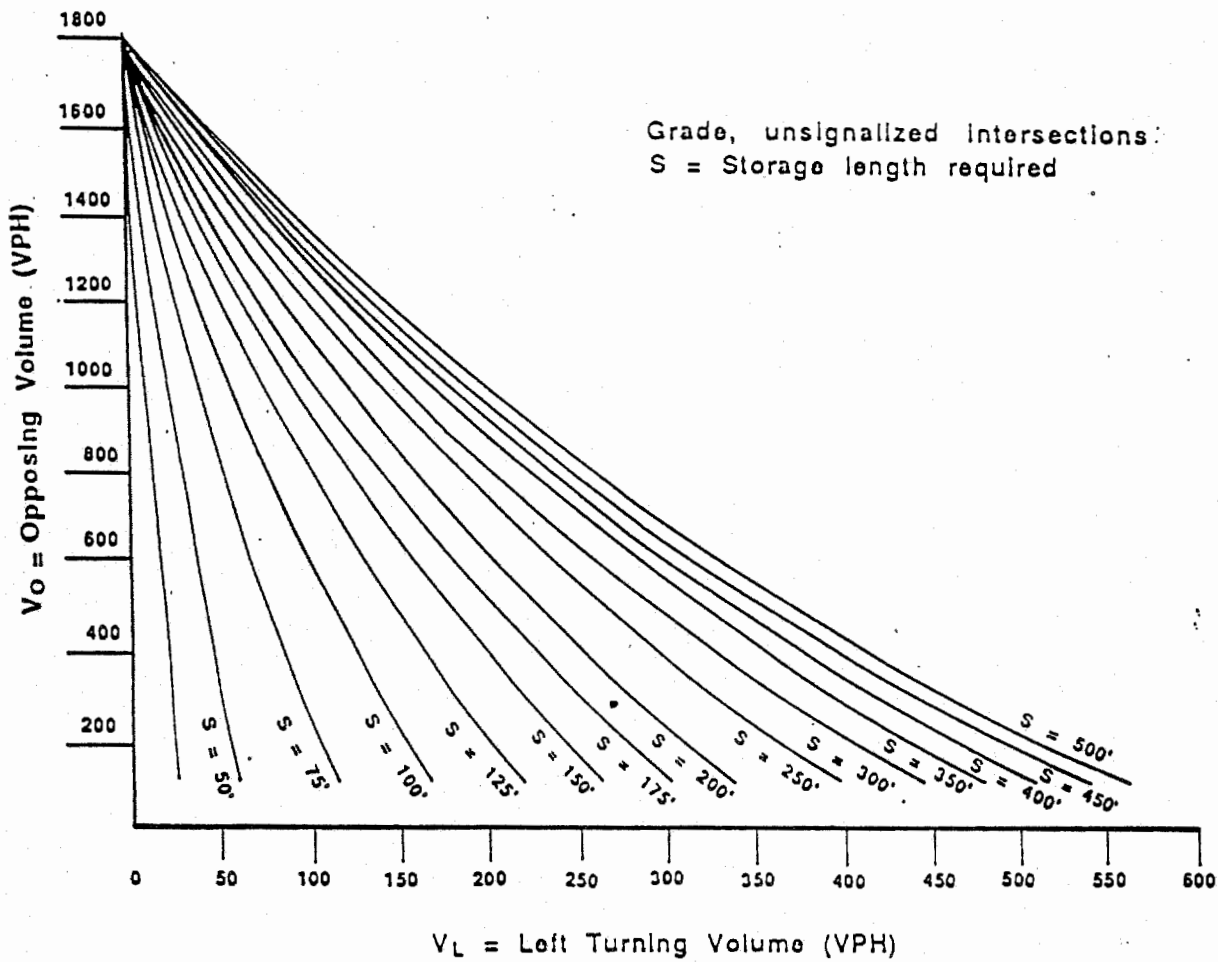

Design of Left Turn Storage Length
Volume-Based Chart for at-Grade
Unsignalized Intersections
on Four Lane Roadways

FIGURE 8-8B

SECTION 8.8 HORIZONTAL CONTROL CRITERION

In order to provide safe continuous operation on county streets, the street design parameters should be in balance with the anticipated speed. Both the horizontal and vertical control should also be in balance with each other.

In horizontal design, it some times becomes necessary to provide superelevations in order to counter balance the centrifugal force when a vehicle moves in a circular path.

Local and Collector Roads are normally designed without the benefit of superelevations, since the speed in residential areas need to be kept at an acceptable level. Secondary highways and other four and six lane arterials may need to be superelevated. However, Director of Transportation approval is essential prior to the use of superelevations. The guide lines for superelevations shall be as directed by Caltrans Highway Design Manual except maximum superelevation rate of 5% (0.05) should not be exceeded.

The minimum horizontal radius for speeds less than 35 MPH shall be in accordance with A Policy on Geometric Design of Highways and Streets, Figure 8-10, for speeds in excess of 35 MPH, refer to the Caltrans Highway Design Manual, Figure 8-9.

Horizontal curves near intersections should be avoided on Secondary and Major Highways. When horizontal curves are proposed on Local or Collector Streets near intersections, the curve should terminate a minimum of thirty (30) feet from the curb return.

Figure 8-9
Comfortable Speed On
Horizontal Curves

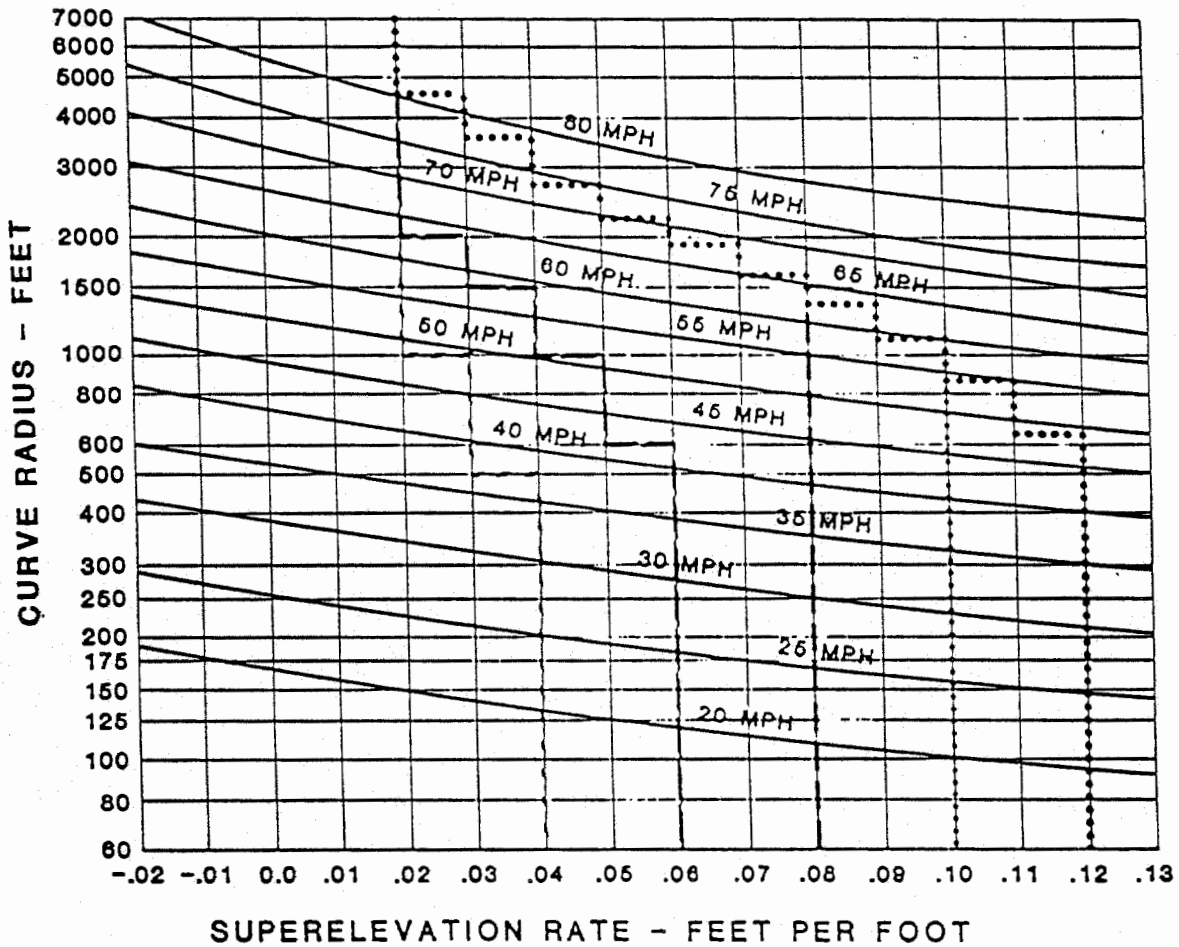

NOTES:

- SYMBOL LINES indicate standard superelevation rates for various e_{max} values as listed in Index 202.2.
- Higher value at steps is the proper superelevation for indicated curve radius.

e - SUPERELEVATION
 f - SIDE FRICTION FACTOR
 V - SPEED IN MILES PER HOUR
 R - RADIUS IN FEET

$$e + f = \frac{0.067V^2}{R}$$

SPEED	DESIGN SIDE FRICTION FACTOR
20	0.17
30	0.16
40	0.15
50	0.14
60	0.12
70	0.10
80	0.08

Legend: - · - = .04 e_{max}
 — = .08 e_{max}
 — = .08 e_{max}
 ··· = .10 e_{max}
 ··· = .12 e_{max}

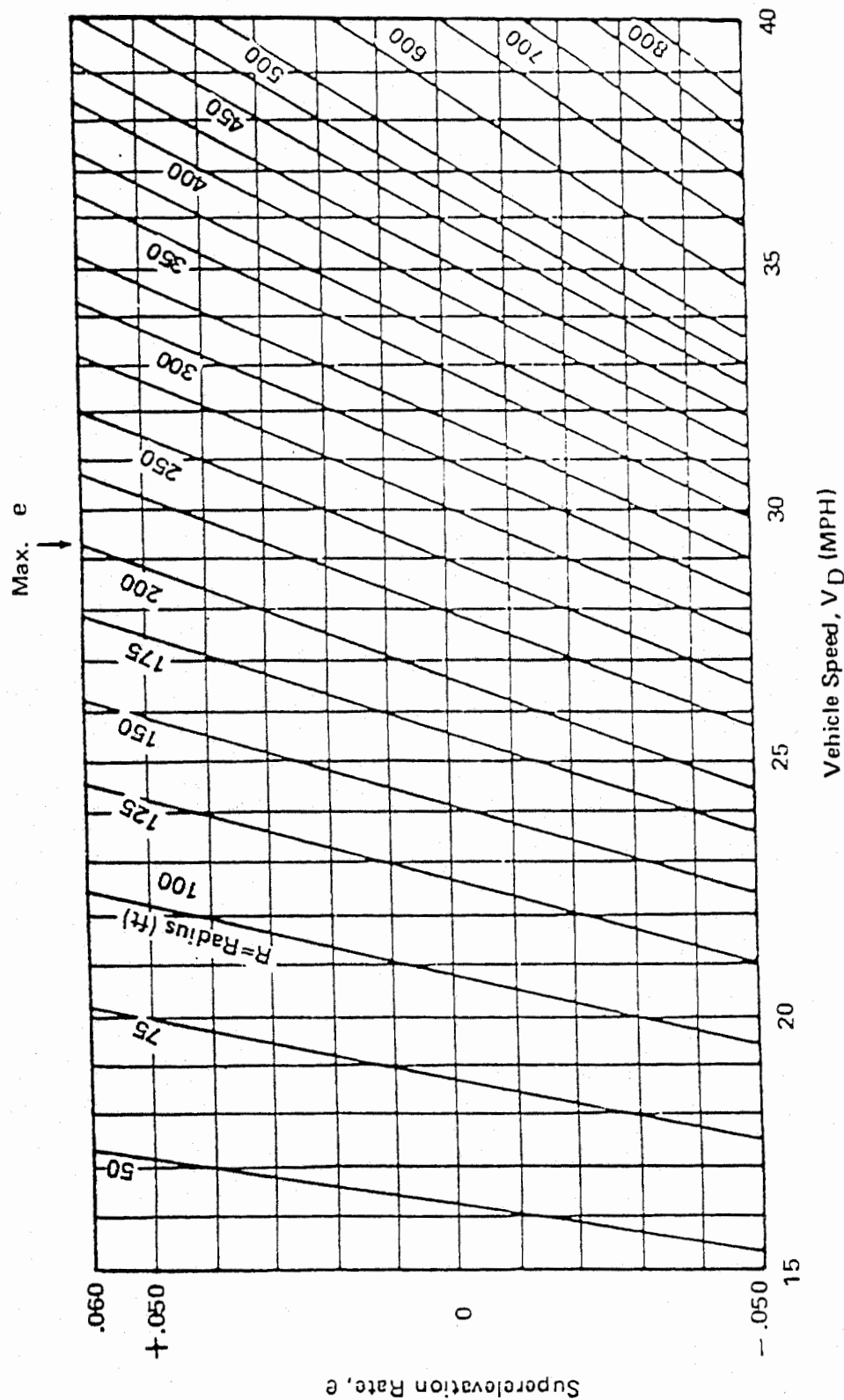

Figure 8-10 Maximum safe and comfortable speed for horizontal curves on low-speed urban streets.

SECTION 8.9 STREET GRADIENT

1. When any road is extended to a subdivision boundary for the purpose of providing a future connection to adjoining property, the subdivider shall submit an alignment and profile demonstrating the feasibility of such future extension.
2. Minimum street grades on any street or alley shall be 0.5%.
3. For maximum grades refer to sections on Valley Design Standards, Desert Design Standards or Mountain Design Standards.
4. The maximum grade for a permanent cul-de-sac street turning area shall be 5% (0.50% minimum). The maximum grade for a temporary cul-de-sac street turning area shall be 8%.
5. At signalized intersections, the maximum grade is 3% within the intersection and for 200 feet in each direction.
6. The maximum grade at any intersection of two streets shall be 6% within the intersection and for at least 50 feet from the curb return.
7. The use of concrete cross-gutters shall be limited to Local or Collector roads. Major or Secondary streets will require underground drainage systems.
8. When cross gutters are to be constructed, the centerline grade on the side street will be carried up from the lip of the cross gutter at a maximum rate of 3%, on a through intersection and maximum 6% if a force Tee intersection. This grade will join a desirable grade on side street with a true vertical curve. The length of the vertical curve can be obtained from the formula:

$$L = \frac{1.2 AV^2}{100}$$

where L = length of V.C. in feet (Normally 40 foot)

A = Algebraic difference in grades in percent
(G₁ - G₂)

V = design speed in mph

SECTION 8.9 STREET GRADIENT

1. When any road is extended to a subdivision boundary for the purpose of providing a future connection to adjoining property, the subdivider shall submit an alignment and profile demonstrating the feasibility of such future extension.
2. Minimum street grades on any street or alley shall be 0.5%.
3. For maximum grades refer to sections on Valley Design Standards, Desert Design Standards or Mountain Design Standards.
4. The maximum grade for a permanent cul-de-sac street turning area shall be 5% (0.50% minimum). The maximum grade for a temporary cul-de-sac street turning area shall be 8%.
5. At signalized intersections, the maximum grade is 3% within the intersection and for 200 feet in each direction.
6. The maximum grade at any intersection of two streets shall be 6% within the intersection and for at least 50 feet from the curb return.
7. The use of concrete cross-gutters shall be limited to Local or Collector roads. Major or Secondary streets will require underground drainage systems.
8. When cross gutters are to be constructed, the centerline grade on the side street will be carried up from the lip of the cross gutter at a maximum rate of 3%, on a through intersection and maximum 6% if a force Tee intersection. This grade will join a desirable grade on side street with a true vertical curve. The length of the vertical curve can be obtained from the formula:

$$L = \frac{1.2 AV}{100}$$

where L = length of V.C. in feet (Normally 40 foot)

A = Algebraic difference in grades in percent

V = design speed in mph

Following the above procedure, it is not possible or desirable in most cases to obtain full crown at the B.C.R. and therefore, the typical section does not apply. The designer should show enough elevations on the plan to define the section. The designer should also be cognizant of extremely long vertical curves which can produce prematurely "sheet flow" near the intersection.

SECTION 8.10 VERTICAL CURVES

Vertical curves should provide for a safe design, pleasing appearance, drainage control and comfort in operation.

The design control for crest vertical curves shall be based on stopping sight distance and headlight sight distance for sag curves. The designer should not design primarily for comfort on sag curves, since the length of vertical curve is only 50 percent of that required to satisfy the headlight distance. The crest and sag vertical curves shall be designed in accordance with "A Policy on Geometric Design of Highways and Streets" or "California Department of Transportation Highway Design Manual".

The roads should be designed to encourage uniform operation throughout. Therefore, avoid short breaks in the profile. If change in gradient is necessary, this must be accomplished by vertical curves per above mentioned standards. The minimum length of a vertical curve shall be 100 feet, except as mentioned in Section 8.9, if the algebraic grade difference is 1.0% or greater.

Figure 8-11

Stopping Sight Distance on Sag Vertical Curves

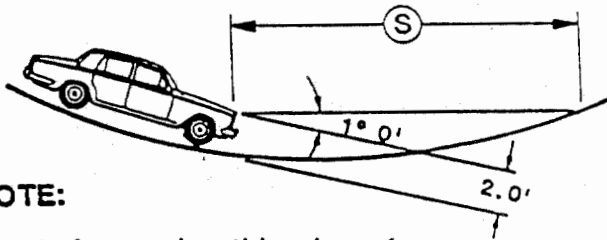

NOTE:

- Before using this chart for intersections, branch connections and exits, see Index 201.7, 405.1 and 504.2.
- For sustained downgrades, see Index 201.3.
- See Figure 204.4 for vertical curve formulas.
- See Index 204.4 for minimum length of vertical curve.

L = CURVE LENGTH - FEET
 A = ALGEBRAIC GRADE DIFFERENCE - %
 S = SIGHT DISTANCE - FEET
 V = DESIGN SPEED - M.P.H. FOR "S"
 K = DISTANCE IN FEET REQUIRED TO ACHIEVE A 1% CHANGE IN GRADE.
 K VALUE SHOWN IS VALID WHEN S < L.

WHEN S > L
$L = 2S - \frac{400 + 3.5S}{A}$

WHEN S < L
$L = \frac{AS^2}{400 + 3.5S}$

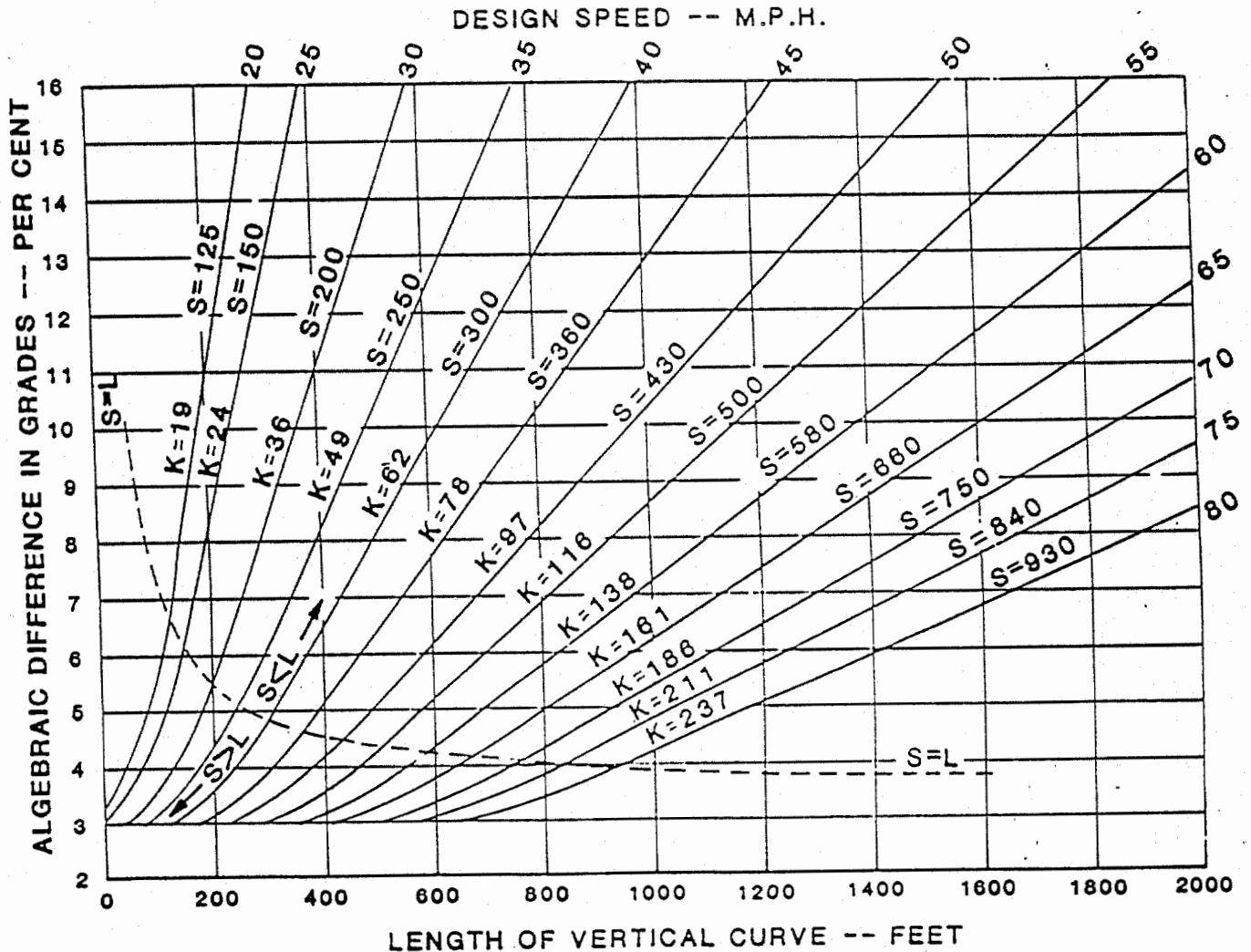

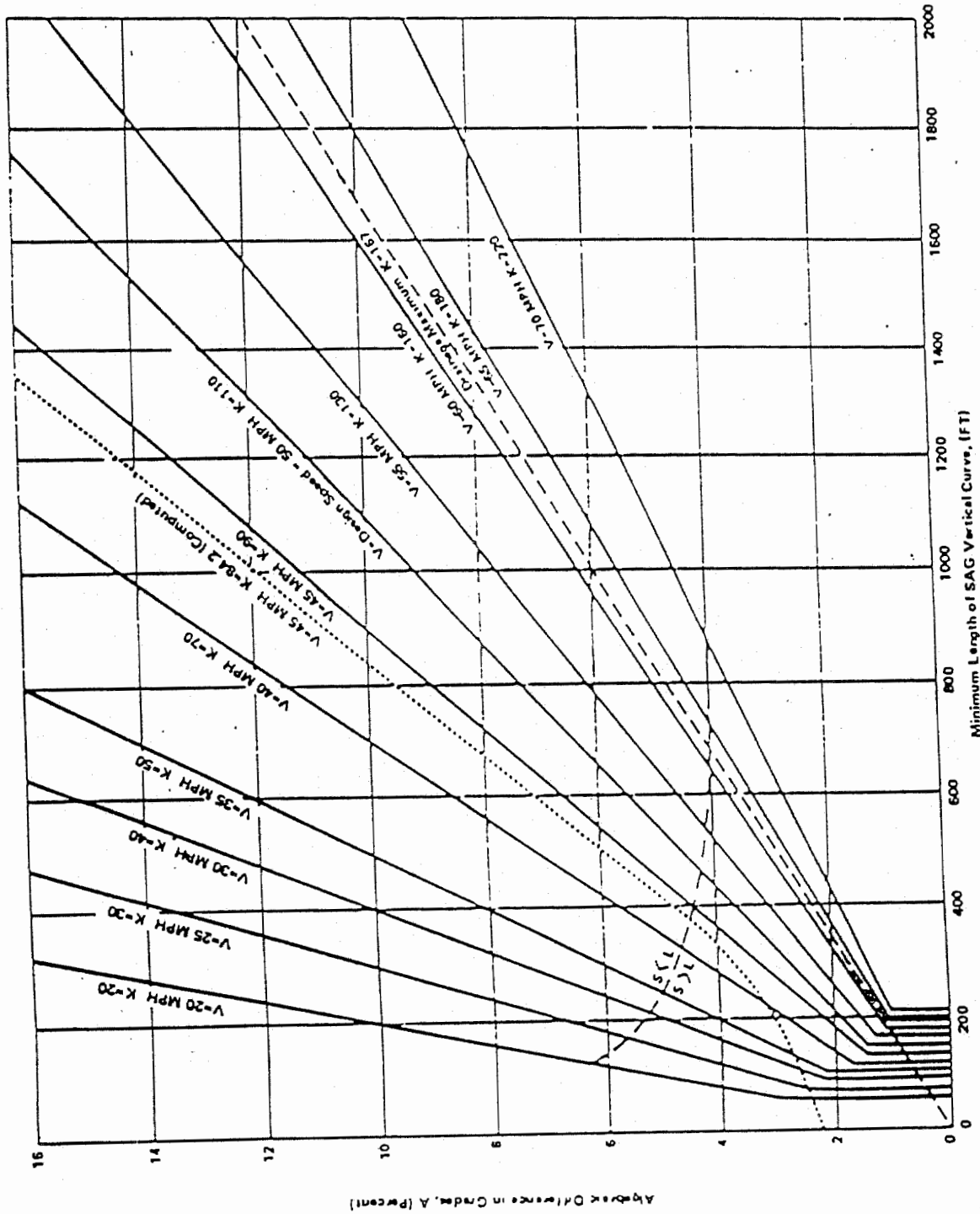

Figure 8-12 Design controls for sag vertical curves, open road conditions.

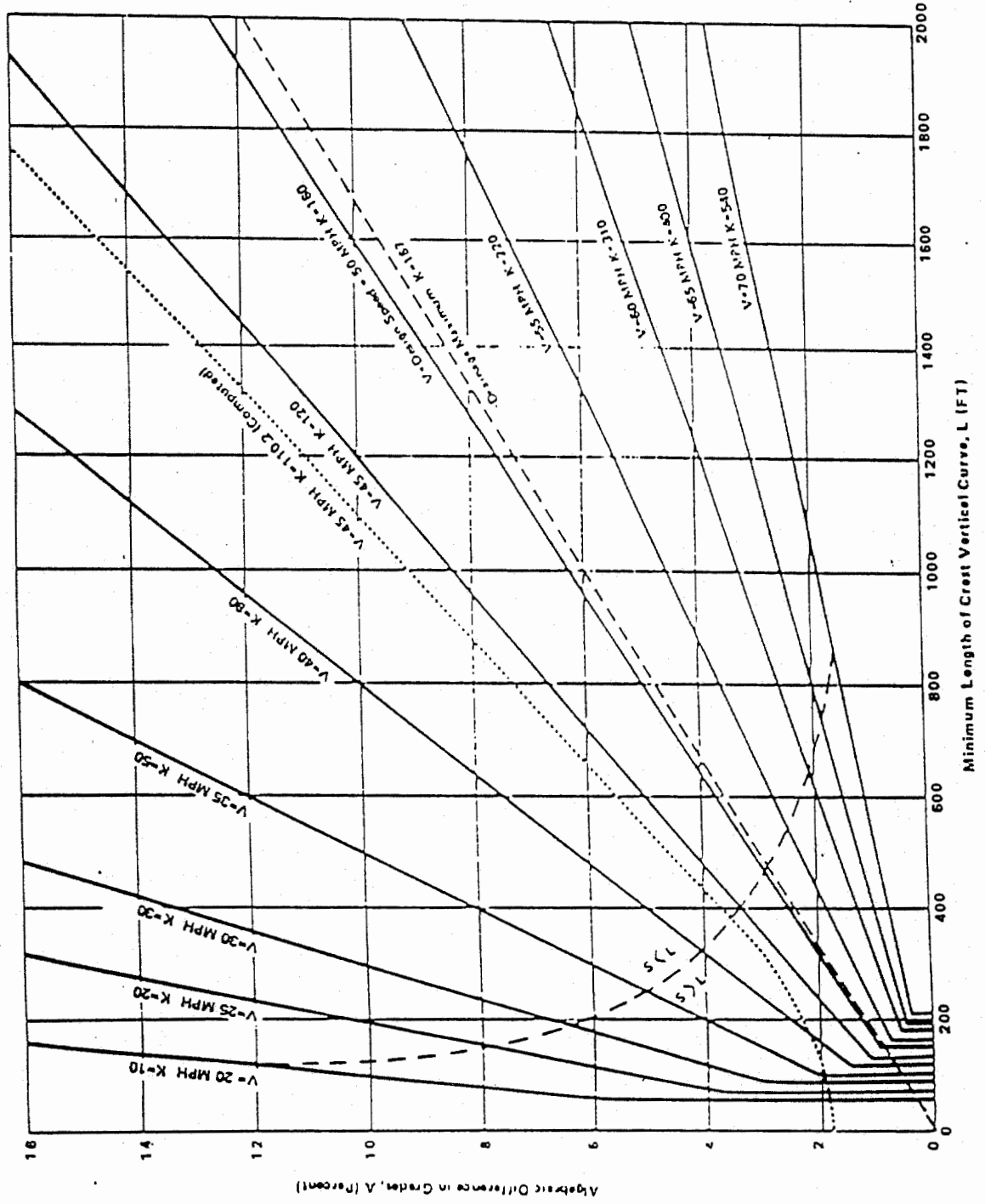
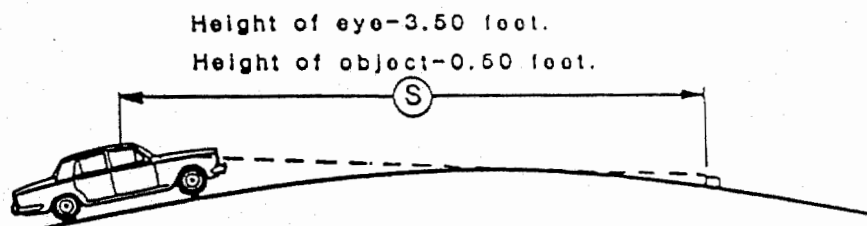

Figure 8-13 Design controls for crest vertical curves, for stopping sight distance and open road conditions.

May 2, 1988

Figure 8-14

Stopping Sight Distance on
Crest Vertical Curves



NOTE:

- Before using this chart for intersections, branch connections and exits, see Index 201.7, 405.1 and 504.2.
- See Figure 204.4 for vertical curve formulas.
- See Index 204.4 for minimum length of vertical curve.

L = CURVE LENGTH - FEET
 A = ALGEBRAIC GRADE DIFFERENCE - %
 S = SIGHT DISTANCE - FEET
 V = DESIGN SPEED - M.P.H. FOR "S"
 K = DISTANCE IN FEET REQUIRED TO ACHIEVE A 1% CHANGE IN GRADE.
 K VALUE SHOWN IS VALID WHEN S < L.

WHEN S > L
$L = 2S - \frac{1328}{A}$

WHEN S < L
$L = \frac{AS^2}{1328}$

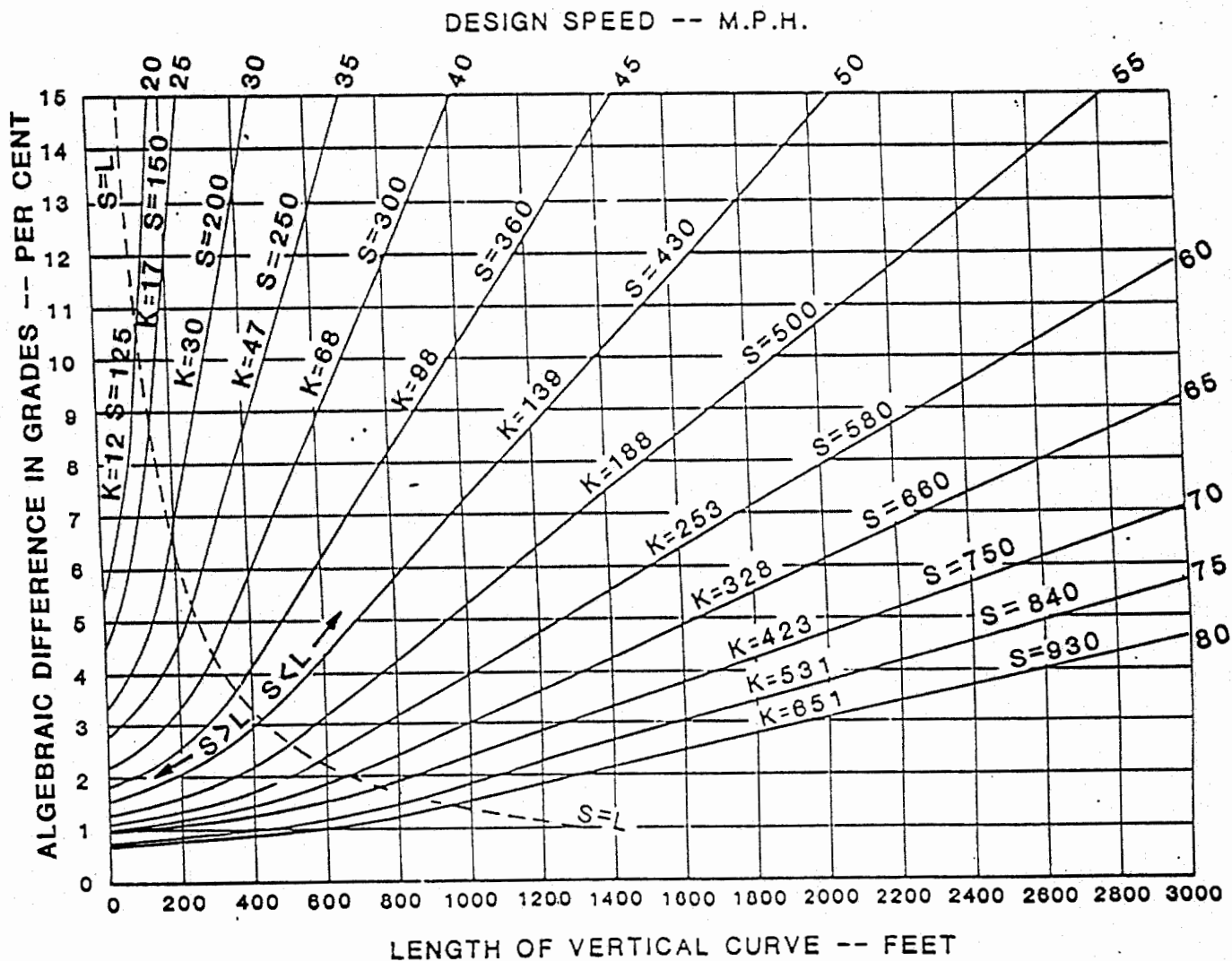

SECTION 8.11 CURB RETURN DESIGN

To avoid awkward construction situations requiring field adjustment of profile elevations, the two intersecting streets should be in the same plane, in other words no break in grade should occur at the BRC or at the ECR. In order to do so, a vertical curve should be introduced beyond the ECR or BCR or both. In the following chart the ECR is assumed to be on the Control Street and the BCR on "X" Street, also we will be concerned with one vertical curve only being introduced outside of the BRC.

For a Central Angle between 85° and 95°, multiply the difference by the Trigonometric Ratio, R=0.41, for a central angle of any degree the trigonometric ratio may be found by the formula:

$$R = \frac{\cos 1/2 \text{ Delta}}{1 + \cos 1/2 \text{ Delta}}$$

85° to 95° CURB RETURN DESIGN

1. Plot FL Grade of Control St. to P.I. Line
2. Plot Grade line from FL. of P1 to 10' beyond ECR to FL. Grade of 'X' street.
3. Determine E.C.R. elev- find mean (M) between B.C.R. elev. & E.C.R. elev.
4. MOC elev = $M \pm 0.41x$ (diff between M & P.I. elev.)

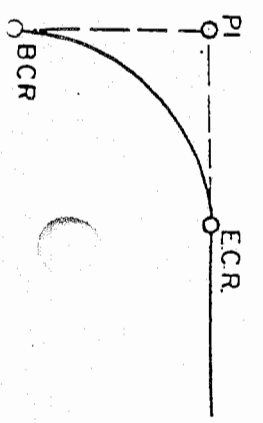
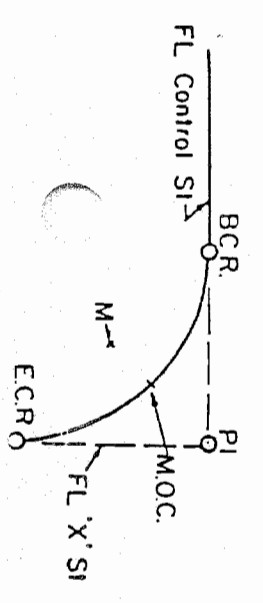
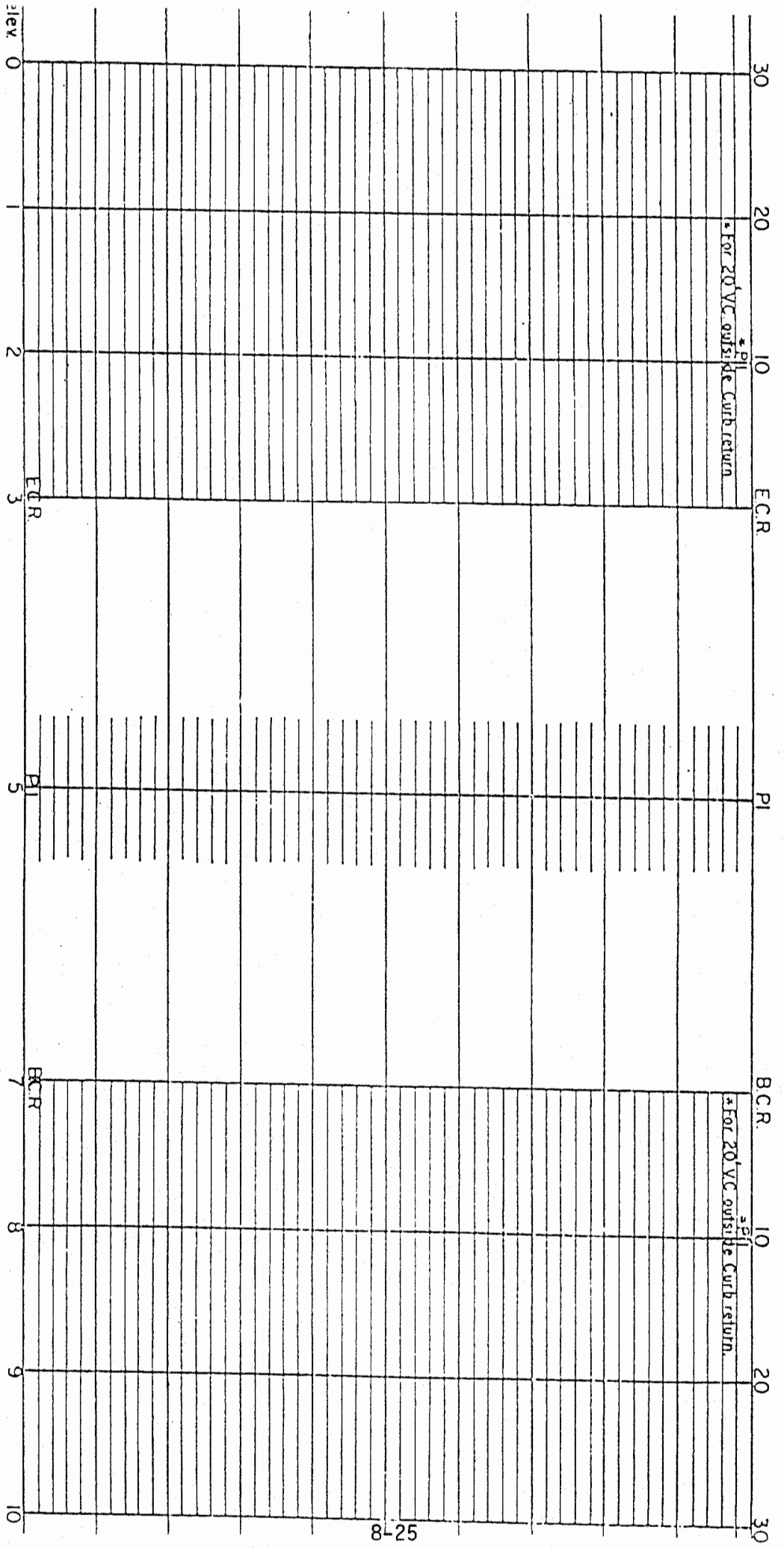
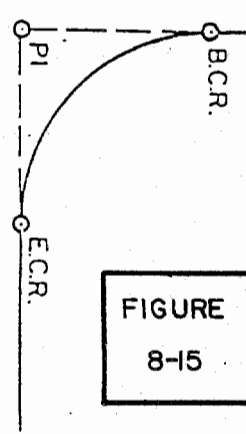
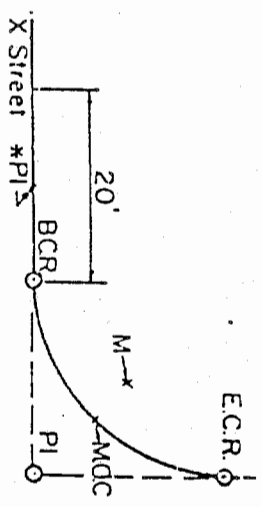

FIGURE 8-15

ARTICLE IX
STRUCTURAL SECTION DESIGN

SECTION 9.1

TRAFFIC INDEX (TI)

Traffic Index (TI) is provided by the Transportation Department, Traffic Division. A 10-year design life is normally used but a 20-year design period may be required on Federal-Aid and major highways.

Traffic Indexes within residential subdivisions T.I. for local streets and collector streets may be determined by Chart I but in no instance will the T.I. be less than the following:

Collector	5.5
Local Street (60 r/w)	5.0
Cul-de-sac	4.5

CHART FOR ESTIMATION OF TRAFFIC INDEX
USING A HOUSE COUNT

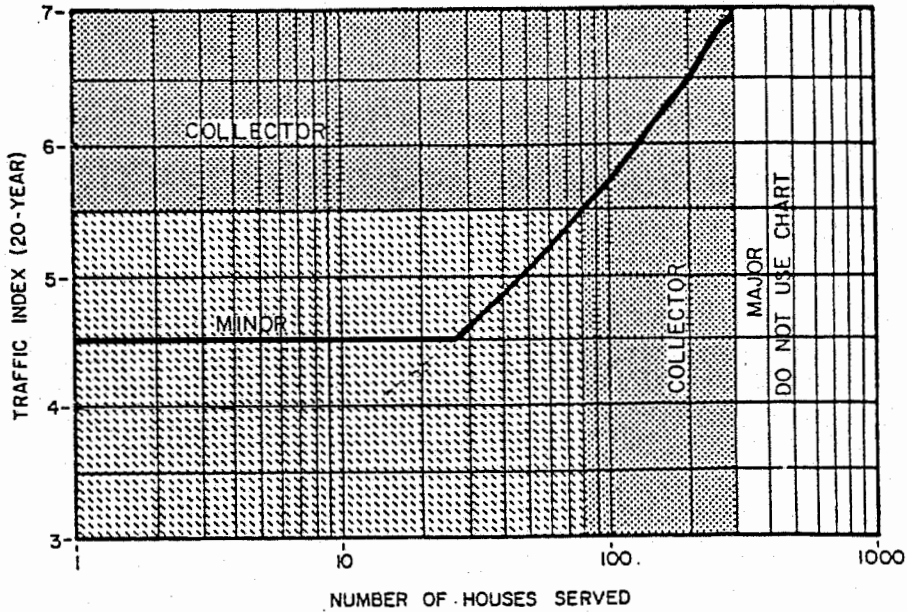

* T.I. = 2.472 (HOUSES)^{0.1825} MIN. T.I. = 4.0

Notes: For use only within subdivisions for residential and residential collector streets.

Chart is based on a 20-year design life.

Chart 9-1

Traffic Index Chart for Flexible Pavements

SECTION 9.2 STRUCTURAL SECTIONS

All streets shall be designed in accordance with the following specifications:

1. Asphalt Concrete (AC) Pavements -

Structural section design for AC Pavement is based on the following 8 1/2" x 11" paperback booklet:

Flexible Pavement Structural
Section Design Guide For
California Cities and Counties
January, 1979

This Design Guide is presently being revised by CALTRANS and should become available in the near future. The new design guide will also contain Portland Cement Concrete Pavement design requirements.

2. Portland Cement Concrete Pavement (PCCP) -

Until the new design guide is published, PCCP design shall be based on Topic 607, "Portland Cement Concrete Pavement Structural Section Design" Caltrans Highway Design Manual, August 5, 1988. PCCP design will be based on the new revised Structural Section Design Guide when it becomes available.

3. Sampling and Testing

Sampling and testing is performed at the completion of rough grading in accordance with Section 6 (d) of the San Bernardino County Standards and Specifications. A copy of this section may be obtained from the Pavement Management Section, 825 E. Third Street, San Bernardino, CA 92415-0835. The stated requirements of Section 6 (d) are minimums. Additional sampling and testing shall be performed when physical appearance of soil changes and/or when required to isolate poor soil areas.

4. R-Value

R-value of the subgrade soils shall be determined in accordance with California Test Method No. 301. The R-value by stabilometer is taken at 300 p.s.i. exudation pressure. Since design is based on the poorest soil encountered, sieve analysis and sand equivalent tests are used to determine the poorest soil in order to reduce the number and cost of R-Value tests. However, where large areas of good and bad material make it economically advantageous to change the design at intervals, additional R-Value testing shall be performed to establish limits of the varying soil types. The maximum Design R-Value used for Untreated Native Soil is 70.

5. Expansive Soil

If the soil is expansive the R-value shall be determined by expansion pressure. Sufficient molds shall be fabricated to allow determination of equilibrium thickness by interpolation of the stabilometer thickness vs. expansion thickness curve. If extrapolation is used, a line shall be drawn from the left end point of the thickness plot perpendicular to the 45 degree line. The equilibrium thickness may be taken from the intersection of the perpendicular line with the 45 degree line. This approach is only intended for short distances from the endpoint.

6. Design R-value

The lowest value of the two R-values, (i.e., R by exudation and R by expansion) is termed R-value at equilibrium and shall be used in the design of a structural section. The Director of Transportation may reduce the design R-value to a lower equilibrium value when poor soil characteristics and excessive moisture are encountered in the subgrade soil.

7. Minimum Thickness of Structural Elements

In addition to satisfying the design formula and safety factor requirements, the following minimum thicknesses are required:

<u>Material</u>	<u>M i n i m u m Thickness</u>
Asphalt Concrete (AC) (Two-lift Construction Required)	0.25'
Class 2 Aggregate Base (CL 2 AB)	0.35'
Cement Treated Base (CTB)	0.40'
Class 3 Aggregate Base	0.50'
Aggregate Sub Base (AS)	0.50'
Lime Treated Soil (LTS)*	0.50'
Cement Treated Soil (CTS)*	0.50'

* When LTS or CTS are used, an intervening "relief" layer of CL 2 AB (0.35'thick) is required between these layers and the AC.

8. Safety Factors

The following safety factors, in terms of GE (in feet) shall be added to the AC layer GE and subtracted from the subbase layer GE. Where there is no subbase, the safety factor will be subtracted from the base layer, unless the layer is of minimum thickness.

<u>Base Type</u>	<u>Gravel Equivalent Increase (feet)</u>	<u>Layer Applied to</u>
Asphalt Concrete Base (ACB)	0.24	AC
Class A CTB	0.24	AC
Lean Concrete Base	0.24	AC
Class B CTB	0.20	AC
Aggregate Base (AB)	0.20	AC
Lime Treated Soil (LTS)	0.20	AC
Full depth AC over Native	0.10 *	AC

* The Safety factor of 0.10 is added to the total calculated GE required over the native soil before calculating the AC thickness.

9. Rounding off

When the thickness of a structural layer calculated by formula is greater than the minimum thickness required, the required thickness shall be rounded as follows:

<u>Layer</u>	<u>Round off To</u>
AC	Nearest 0.01'
All Others	Next larger 0.05'

10. Specified R-Values and Gravel Equivalent Factors

<u>Material</u>	<u>R-Value</u>	<u>Gravel Equivalent Factor</u>
Native Soil	By Test, 70 Max.	NA
Class A CTB	80	1.7
Class B CTB	80	1.2
Class 2 AB	78	1.1
Class 3 AB *	70	1.0
LTS	By Test, 70 Max.	1.0
CTS	By Test	1.0
Class 1 ASB	60	1.0
Class 2 ASB	50	1.0
Class 3 ASB	40	1.0
AC	NA	$2.5(5.14/T.I.)^{0.5}$

* Class 3 AB is allowed only when Class 2 AB is not commercially available within 50 miles haul distance, one-way.

11. Submittals

A copy of the materials report and structural section recommendations shall be submitted for review and approval to:

San Bernardino County
Transportation and Flood Control Department
Pavement Management Section
825 East Third Street
San Bernardino, California 92415-0835

The submittal shall include a plat showing the location of sampling, a tabulation of sieve analysis and sand equivalent test results, a statement of recommended structural section, and test data sheets for all R-Value tests performed, including expansion pressure readings, etc.

ARTICLE X
TRAFFIC STUDIES

SECTION 10.1 TRAFFIC CONGESTION

Traffic congestion on local and regional roads is an important concern for the County. In order to address this problem, the County has developed this manual to address traffic impacts associated with new development.

SECTION 10.2 RESPONSIBILITIES FOR TRAFFIC STUDIES

A written study will typically be required for a development proposal when trip generation during any peak hour is expected to exceed 100 trips or there is a significant traffic impact as defined in Section 10.12.D, or as directed by the Director of Transportation.

This study will be the responsibility of the applicant. All traffic studies must be prepared by a registered professional Traffic or Civil Engineer with adequate experience in Traffic Engineering.

Upon submittal of a draft traffic study, the Traffic Division will review study data sources, methods, and findings. Written comments will be provided to the Land Development Engineering Division. The developer and the private engineer will then have an opportunity to incorporate necessary revisions prior to submitting a final report.

At any time in the review process, the applicant will be required to update the existing traffic study if the land use intensity is increased or the land use is changed so that trip generation is increased. All previous traffic studies relating to the development that are more than one year old will have to be updated unless the Director of Transportation determines otherwise.

If access points are not defined at the time the traffic study is prepared, a revised traffic study may be required when access points are defined.

Transportation engineers preparing traffic studies are required to discuss projects with the Traffic Division and Land Development Engineering Division prior to starting the study. At a minimum, topics for possible discussion will include trip generation, directional distribution of traffic, trip assignment, definition of the study area, intersections requiring critical lane analysis, methods of projecting cumulative traffic demands at buildout conditions, and possible design year.

This is intended to provide a firm base of cooperation and communication among the County, the developer, and the private engineers in order to forecast future traffic characteristics that realistically define traffic movement associated with the proposed development. Specific requirements will vary depending on the site location.

SECTION 10.3 TRAFFIC STUDY FORMAT

In order to provide consistency and facilitate staff review of traffic studies, the following format shall be followed as outlined below. A summary outline is provided in Section 10.4.

SECTION 10.4 INTRODUCTION (SECTION 10.17, ITEM 6)

The introduction portion of the report must contain the following:

A. Land Use, Site and Study Area Boundaries

A brief description of the size of the parcel, general terrain features and location within the local area must be included in this section. In addition, the roadways that afford access to the site, and are included in the study area, must also be identified.

The exact limits of the study area should be based on the potential impact of the proposed project on the street network and an understanding of existing traffic conditions surrounding the site. A vicinity map which illustrates the site and study area boundaries, in relation to the surrounding transportation system, must be included.

B. Existing and Proposed Site Uses

The existing and proposed uses of the site must be identified in terms of the various land use districts of the County. In addition, the specific use for which the request is being made must be identified, if possible, since a number of uses may be permitted under existing General Plan. This information should include the square footage of each use or number and size of units proposed and, if applicable, the hours of operation of the use.

The intent of the traffic study is to evaluate worst case traffic impacts allowed by land use districts. If several different uses are permitted by the districts, the land use with the greatest overall traffic impact must be assumed for the study.

C. Existing and Proposed Uses in Vicinity of Site and Site Access

The most current list of tentative developments must be obtained from the Planning Department. A complete description of all tentative and approved developments within the study area and their proposed uses must be provided. One hundred percent (100%) occupancy must be assumed for all developments in the cumulative analysis.

If approved uses have not been determined, the County approved estimate of the probable future uses, based on land use districts, should be utilized. The latter is especially important where large tracts of undeveloped land are in the vicinity of the site, and within the study area.

A site plan must be included in the report, showing the proposed points of access. If necessary, a separate large scale print of the site plan may accompany the report.

D. Existing and Proposed Roadways and Intersections

Within the study area, the applicant shall describe and provide volumes for existing roadways and intersections including geometric and traffic signal control, as well as improvements that have been funded by government agencies or other developments. This list would include the nature of the improvement project, its extent, implementation schedule, and the agency or funding source responsible.

SECTION 10.5 PROJECT TRIP GENERATION AND DESIGN HOUR VOLUMES (SECTION 10.17, ITEM 7)

A summary table listing each type of land use, corresponding size, the average trip generation rates used (total daily traffic and AM/PM peak hours of the street), and the resultant total trips generated must be provided for the project site and all tentative and approved projects.

The calculation of design hour traffic volumes used to determine study area impacts shall be based on the maximum area allowed under existing (or proposed) land use and the following trip generation data sources:

- A. Trip generation rates provided in "Institute of Transportation Engineers (ITE) Trip Generation", latest edition.
- B. If no published rates are available, recent traffic volume counts for a similar existing use may be utilized with approval.
- C. Additional sources from other jurisdictions, such as Caltrans, may be utilized with approval.
- D. For mixed use developments, if ITE rates are used to estimate average daily traffic, the PM peak hour of the street may be estimated by using 10% of total average daily traffic.

Any internal trip reductions and modal split assumptions will require analytical support to demonstrate how the figures were derived and will require approval. Internal trip reductions will not be permitted for County trip generation rates.

SECTION 10.6 TRIP DISTRIBUTION (SECTION 10.17, ITEM 8)

The estimates of percentage distribution of trips from the proposed development to destinations both within and outside the community must be clearly stated in the report.

A map showing the percentage of site traffic on each street, based on average daily volumes, must be provided as part of the traffic study graphic material.

SECTION 10.7 TRIP ASSIGNMENT (SECTION 10.17, ITEM 9)

The directions of approach and departure of site generated traffic, via the area's street system, will be presented graphically. The technical analysis steps, basic methods, and assumptions used in this work must be clearly stated and approved.

The assumed trip distribution and assignment must represent the most logically traveled route for drivers accessing the proposed development. These routes can be determined by observation of travel patterns to and from the study area.

SECTION 10.8 EXISTING AND PROJECTED TRAFFIC VOLUMES (SECTION 10.17, ITEM 10)

Graphics must be provided that show the following traffic impacts for intersections, streets, and all other access points:

- A. Existing p.m. peak hour site traffic (in and out) including turning movements.
- B. Projected p.m. peak hour site (or project) traffic plus the existing traffic from (A) above, including turning movements.
- C. Projected p.m. peak hour traffic totals including site generated traffic (in and out). These volumes must include through and turning movement volumes and a separate set of numbers which include all projects specified in the cumulative analysis. These two must be summarized and labeled "Cumulative."
- D. Any other peak hour which is determined by the County to be critical to site traffic and the street system in the study area should be included in the graphics and show the same information provided for the AM/PM peak hours; for example, recreational and seasonal traffic may generate different peak hour trips.
- E. Actual counts of existing total daily traffic for the street system in the study area at the time the study is prepared.
- F. Projected total daily traffic for the street system in the study area, based on traffic from the proposed development and counts of existing daily traffic obtained in item "E." The component of the existing daily traffic, attributable to existing uses, must be identified, as well as the increase in total daily traffic from proposed uses in the project.
- G. Projected total daily traffic for the design year on the street system in the study area, based on traffic from the proposed development, counts of existing daily traffic obtained in item "E" above, and traffic projections based on all projects specified in the cumulative analysis.

Where necessary, volume projections for background traffic growth will be provided by the Transportation Department, or alternatively, a method for determining the volume will be recommended.

All total daily traffic counts shall be actual machine counts and not based on factored peak hour sampling. Latest available machine counts from Caltrans, the Transportation Department, or other public agencies may be acceptable. If the counts are more than 2 years old, San Bernardino County Transportation County Master Station factors shall be used to bring the count(s) current.

SECTION 10.9 CAPACITY ANALYSIS (SECTION 10.17, ITEM 11)

A capacity analysis will be conducted for each critical intersection. All impacted public street intersections and private property access points adjacent to the proposed development, within the limits of the previously defined study area, will be included in the analysis.

The traffic study shall recommend feasible mitigation measures to bring the intersection Level of Service within acceptable standards, except where mitigation measures have already been identified by the County or through any approved Traffic Mitigation Fee Program. At such locations, measures to improve Level of Service that could be funded by the development may be required.

All calculations shall recognize special phasing arrangements where applicable.

All Levels of Service shall be provided with corresponding volume to capacity ratios (V/C). Drawings of lane configurations assumed in Levels of Service calculations shall be included in the report. Calculations must conform to the 1985 Highway Capacity Manual (HCM) including the delay methodology. Software is available for these calculations from FHWA of CAPPSTI or other approved methods.

SECTION 10.10 TRAFFIC SIGNALS (SECTION 10.17, ITEM 12)

The need for traffic signals will be based on warrants contained in the Caltrans Traffic Manual, Manual on Uniform Traffic Control Devices or any warrants established by the California Committee on Uniform Traffic Control Devices.

In determining the need for a signal, traffic progression is of paramount importance. Whenever there is a conflict, State Standards will take precedence.

Pedestrian movements must be considered in the evaluation, adequate pedestrian clearance must be provided in the signal cycle split assumptions.

To provide flexibility for existing conditions and ensure optimum two-way signal progression, an approved traffic engineering analysis must be made to properly locate all proposed accesses that may require signalization.

The section of roadway to be analyzed for signal progression shall include all existing and possible future signalized intersections.

A desirable band width of 50% of the signal cycle shall be used where existing conditions allow. For those intersections that have no signals presently, but are expected to be signalized, typically a 60% mainline, 40% cross street cycle split should be assumed on an arterial where progression is possible.

Cycle split assumptions shall relate to volume assumptions in the capacity analysis of individual intersections. Where computerized progression analysis techniques are used, they shall be of the type which utilize turning movement volume data and pedestrian clearance times in the development of time/space diagrams.

The green time allocated to the cross street will be considered no less than the time which is required for a pedestrian to clear the main street using time calculated for a pedestrian walking at 3.5 feet per second, or as directed by the Transportation Department.

Those intersections that reduce the optimum band width, if a traffic signal were installed, may be required to remain unsignalized and have turn movements limited by access design or median islands.

SECTION 10.11 TRAFFIC ACCIDENTS (SECTION 10.17, ITEM 13)

Traffic accident data for affected street corridors may be required for the study. The study period will normally be three years. Such locations will be specified by the Director of Transportation and data provided by the County.

Where this is necessary, estimates of increased or decreased accident potential shall be evaluated for the development, particularly if the proposed development might impact existing traffic safety problems in the study area. Safety mitigation measures must be included.

SECTION 10.12 RECOMMENDATIONS (SECTION 10.17, ITEM 14)

In the event that an analysis indicates unsatisfactory Levels of Service on study area streets, a description of proposed improvements that return intersections to Level of Service "C" shall be included except at locations where the County has already identified a project. At such location, measures can be recommended that would improve Levels of Service and which could be funded by the development.

These proposals include projects by the County or Caltrans for which funds have been appropriated and obligated. The assumptions regarding all future street land configurations in an analysis will require approval by the County. In general, the recommendation section should include:

A. Proposed Recommended Improvements

This section shall describe the location, nature, and extent of proposed improvements to assure sufficient capacity.

A plan drawing of each improvement should be provided showing the length, width, and other pertinent geometric features of the proposed improvements.

B. Volume/Capacity Analysis at Critical Points

A table must be provided clearly showing Levels of Service at critical points for the following scenarios:

- (1) Existing conditions.
- (2) Existing plus project traffic without mitigation.
- (3) Existing plus project traffic with mitigation by the development (geometric improvements).
- (4) Existing plus project plus cumulative traffic without mitigation.
- (5) Existing plus project plus cumulative traffic with mitigation (geometric improvements).

Only projects proposed by the development can be shown that include unfunded projects as part of the mitigation measures.

C. Traffic Volume Proportions

Percentages based on the traffic impact analysis may be required to determine the proportion of traffic using various public improvements (both existing and proposed) from several developments within the study area.

D. Significant Impact

A project has significant traffic impacts when:

1. The addition of project traffic to an intersection exceeds the thresholds provided in Table 10-1.

TABLE 10-1

INTERSECTION THRESHOLDS OF SIGNIFICANCE
FOR TRAFFIC IMPACT STUDIES

<u>EXISTING LOS</u>	<u>TOTAL PROJECT PEAK HOUR TRIP GENERATION</u>
A	500
B	250
C	150
D	50
E	30
F	15

2. The Project's access to a major street requires an access that would create an unsafe situation or a new traffic signal, and/or major revisions to an existing traffic signal.
3. The Project adds traffic to a street with design features (e.g., inadequate geometric narrow width, road side ditches, sharp curves, poor sight distance, inadequate pavement structure) that may cause potential safety problems with the addition of project traffic.

SECTION 10.13 REVISIONS TO TRAFFIC STUDY

Revisions to Traffic Study

Revisions to the traffic study must be provided, as required by the County. The County will determine whether revisions are necessary. The need for revisions will be based on the completeness of the traffic study, the accuracy of the data, the thoroughness of the impact evaluation, the compatibility of the study with the proposed access and development plan, and other considerations.

SECTION 10.14 EXECUTIVE SUMMARY

The Executive Summary of the report must be a clear, concise description of the study findings. It must include a general description of all data, County's project number, project scope and purpose, findings, conclusions, mitigation measures, and recommendations.

Technical publications, calculations, documentation, data reporting, and detail design must not be included in this section. The Executive Summary should be no longer than two pages, complete in itself, and not dependent on supplementary data included by reference.

SECTION 10.15 TECHNICAL REQUIREMENTS OF FINAL REPORT

The Final Report must also meet the following requirements:

A. Computerized Analysis

All computerized analysis output sheets and supporting raw count data, both ADT and turning movement, and intersection delay data must be submitted with draft reports for review. All assumptions used in the calculations must be referenced to the appropriate table, chart or page in the approved publication (e.g., V/C ratios, operating speeds, etc.). Calculations must be comprehensive and presented in a clear manner.

B. Graphics

All maps and graphics involving improvements must be drawn to scale with roadway geometrics appropriately dimensioned (e.g. street width, lane widths, etc.). Intersection geometrics must include bus stops, parking areas, pedestrian crossings, driveway locations, etc.

C. Passerby Factors

Passerby factors are to be used to reduce the estimated additional total daily traffic to street(s) serving a proposed development. They are not to be applied directly to reduce trip generation and turning movement volumes at driveways serving the proposed development.

D. Raw Count Data

All raw traffic count data (including average daily volume and peak hour turning movement) and analysis work sheets must be provided in the Appendices of the report. Computer printouts may be used as part of the report.

SECTION 10.16 DELIVERABLES

Two copies of the initial traffic study and the Executive Summary must be submitted to the Land Development Engineering Division. A minimum of two weeks should be allowed for staff review.

Reports must be bound on the left-hand edge, 8-1/2" X 11" format, printed on one side. Maps may be no larger than an 11" X 17" fold out. After the final traffic study is approved, the consultant shall submit three copies of the final Traffic Study to Land Development Engineering Division.

SECTION 10.17 TRAFFIC STUDY REPORT OUTLINE

1. TITLE PAGE (Project Name and Number, Name and Address of Company, Licensed Engineer, Tract and Site Appr____ or Other Project Number, Stamp and Expiration)
2. EXECUTIVE SUMMARY (No more than two pages)
3. TABLE OF CONTENTS
4. LISTING OF FIGURES
5. LISTING OF TABLES
6. INTRODUCTION
 - a. Land use, site and study area boundaries (Provide map)
 - b. Existing and proposed site uses
 - c. Existing and proposed uses in vicinity of site (Provide map)
 - d. Existing/proposed roadways and intersections (Provide map)
7. PROJECT RIP GENERATION AND DESIGN HOUR VOLUMES (Provide table)

8. TRIP DISTRIBUTION (Provide map)
9. TRIP ASSIGNMENT (Provide map)
10. EXISTING AND PROJECTED TRAFFIC VOLUMES (PROVIDE GRAPHICS FOR EACH ITEM)
 - a. Existing P.M. peak hour site traffic (including turning movements)
 - b. Projected P.M. peak hour site traffic including Existing and Project (including turning movements)
 - c. P.M. peak hour total traffic including site existing, project and cumulative traffic
 - d. Any other peak hour necessary for complete analysis
 - e. Total daily existing traffic for street system in study area
 - f. Total daily existing traffic for street system in study area plus project traffic
 - g. Total daily existing traffic for street system in study area plus project traffic and cumulative traffic from build-out of approved projects
11. CAPACITY ANALYSIS (Using the 1985 HCM with delay analysis, provide analysis sheets in appendices)
12. TRAFFIC SIGNALS (Planning method if applicable, provide analysis sheets in appendices)
13. TRAFFIC ACCIDENTS (OPTIONAL) (Provide collision diagrams and accident rate)
14. RECOMMENDATIONS
 - a. Proposed recommended improvements
 - b. Traffic volume proportions
 - c. Significant impact

NOTE: Information required on figures may be combined provided that the information is clearly legible.

ARTICLE XI

TRANSPORTATION FACILITIES FEE PLAN

TRANSPORTATION FACILITIES FINANCING PLANS

SECTION 11.1 INTRODUCTION

The following information provides a description of the Transportation Facilities Fee Plan ordinance implemented by the County on March 16, 1987, and subsequent amending ordinances.

It was anticipated by the Board of Supervisors that adoption of the Transportation Facilities Fee Plan would raise additional revenues, enabling the construction of necessary circulation system improvements. These improvements accommodate additional traffic that is generated by development and redevelopment of land within a County community.

The Board of Supervisors approved the Ordinances which contain a fair and equitable method of determining the extent to which development or redevelopment of land would generate traffic volumes impacting the roadway system. It also establishes a fair and equitable method of distributing costs of circulation system improvements to accommodate the traffic volumes generated by development.

SECTION 11.2 INTENT

The intent of a Local Transportation Facilities Plan is to require the payment of fees for new development that is within the boundaries of an adopted plan. Such fees shall be for the purposes of defraying the actual or estimated costs of constructing transportation facilities that are necessary to accommodate vehicular traffic generated by new development.

SECTION 11.3 ESTABLISHMENT OF LOCAL AREA TRANSPORTATION FACILITIES PLANS

- A. The provisions of the fee plans only effect those unincorporated portions of the County that are within the boundaries of an adopted Local Area Transportation Facilities Plan.
- B. Each adopted Local Area Transportation Facilities Plan and accompanying engineer's report identifies the following:
 - (1) The purpose of the fee.
 - (2) The uses which are supportive of the fee and the transportation facilities which will be provided with the fees.
 - (3) A reasonable relationship between the fee's use and the type of development project on which the fee is imposed.
 - (4) A reasonable relationship between the need for the transportation facilities and the type of development project on which the fee is imposed.

- (5) A relationship between the amount of the fee and the cost of the transportation facilities, or portion thereof, attributable to the development on which the fee is imposed.

SECTION 11.4 FEE PAYMENT

- A. Whenever a building or mobilehome setdown permit is issued within the boundaries of an adopted Local Area Transportation Facilities Plan, transportation facilities fees are required to be paid in the amount specified in the Schedule of Fees for each plan.
- B. Fees are required to be paid no earlier than the date of the issuance of the building permit by the Office of Building and Safety and no later than the date of final building inspection.
- C. Fees required for mobilehomes not located within a legally established Mobilehome Park are to be paid no earlier than the date of issuance of the mobilehome setdown permit and not later than the date of the issuance of the Certificate of Occupancy.
- D. Fees for mobilehomes to be located within a legally established Mobilehome Park are to be paid no earlier than the date of issuance of the building permit for the construction of each space or combination of spaces, and no later than the date of the final inspection for such spaces.
- E. The current required fees are listed in the Schedule of Fees for the applicable Local Area Transportation Facilities Plan in County Code Title 1, Division 6, Chapter 2.

SECTION 11.5 FUNDS

- A. A separate fund is established for each Local Area Transportation Facilities Plan and fees collected within the boundaries of each plan are deposited into the applicable fund. Any interest income earned by money in the fund is also deposited in the fund.
- B. Monies in a Transportation Facilities Fund are expended solely for the construction, financing, or purchase of transportation facilities within the boundaries of the Local Area Transportation Facilities Plan, and/or to reimburse the County for the cost of engineering, property acquisition, and administrative services required to design, finance, construct, or purchase facilities in the Local Area Transportation Facilities Plan.
- C. Monies may be advanced by the County to design, construct, finance, or purchase transportation facilities or related administrative services, and to acquire necessary property or right-of-way within the boundaries of an adopted Local Area Transportation Facilities Plan. Money so advanced are reimbursed to the County from the applicable Local Area Transportation Facilities Fund.

SECTION 11.6 FEE CALCULATION

- A. Fees assessed on new development within the boundaries of an adopted Local Area Transportation Facilities Plan do not exceed the estimated cost of providing the transportation facilities identified in the applicable Plan.
- B. Specific fees required for new development are calculated as prescribed by the applicable Local Area Transportation Facilities Plan.

SECTION 11.7 AGREEMENTS BETWEEN THE COUNTY AND A DEVELOPER

- A. Advances - An agreement may be entered into between a developer and the County whereby the developer may advance money for the construction, financing or purchase of facilities, or design of such facilities, within the boundaries of a Local Area Transportation Facilities Plan, provided that the sole security to the developer for repayment of money or other consideration advanced shall be money subsequently accruing in the applicable Local Area Transportation Facilities Fund. Reimbursement shall only be for the amount agreed upon in advance and shall not include interest or other charges. The total amount of money reimbursed within a Local Area Transportation Facilities Plan for one fiscal year shall not exceed approximately twenty-five percent (25%) of the fees collected within such plan area during the same fiscal year, except as may otherwise be provided in the applicable Local Area Transportation Facilities Plan. The agreement shall expire twenty (20) years after the date it was entered into, and any subsequent money paid into the fund shall accrue to the fund without obligation to the developer whose agreement has expired.
- B. Agreement for consideration in lieu of fees - An agreement may be entered into between a developer and the County whereby considerations such as dedication of land, right-of-way, equipment, facilities, actual construction, or design work by a civil engineer may be accepted in lieu of part or all of the payment of transportation facilities fees. Prior to approving such an agreement, the Board of Supervisors shall find that the in lieu consideration is equal to or greater in value than the required fee.

SECTION 11.8 EXCLUSIONS

- A. It is the intent to exclude from the payment of transportation facilities fees the replacement of structures or uses with new structures or uses, that generate the same or a lesser amount of vehicular traffic than those being replaced on the same parcel, including:
 - (1) Legally established existing structures or uses in operation (including mobilehome parks) on the effective date of the applicable Local Area Transportation Facilities Plan. Expansion of such structures or uses shall be subject to such fees.

- (2) Replacements of structures or uses for which fees have been paid where such replaced structure or use generates the same or less traffic as the structure or use for which the fees were originally paid.
- B. Residential Exclusions - No transportation facilities fees shall be required for residential building permits or residential mobilehome setdown permits for the following:
- (1) Alterations, repairs, and construction of garages, carports, accessory storage building, patio covers, swimming pools, spas, boundary or decorative fences, amateur radio devices or earth stations, or any other residential accessory structures.
 - (2) Replacement of a legally established residential dwelling unit, including a unit destroyed or damaged by fire, flood, or other accidents or catastrophe provided that:
 - a. Such a replacement will not result in an increase in the number of residential dwelling units, and;
 - b. The proposed type of residential dwelling unit (i.e., single family, multi family, mobilehome, etc.) is within a fee category, as identified in the applicable Local Area Transportation Facilities Plan, for which the per dwelling unit fee amount is less than or equal to the per dwelling unit amount of the fee category for the dwelling unit to be replaced. If the proposed type of residential dwelling unit is within a fee category for the dwelling unit being replaced, the amount of the fee required shall be the difference between the two fee categories.
- C. Non-Residential Exclusions - No transportation facilities fees shall be required for non-residential uses or buildings for the following activities:
- (1) Alterations and repairs.
 - (2) Replacement of non-residential structures or uses if:
 - a. New or replacement construction will not increase the area or square footage upon which fees are assessed as prescribed in the applicable Local Area Transportation Facilities Plan, and
 - b. The proposed type of structure or use is within a fee category (as identified in the applicable Local Area Transportation Facilities Plan) that has a fee amount that is less than or equal to the amount of the fee category for the structure or use to be replaced. If the proposed type of structure or use is within a fee category that has a fee amount that is greater than the amount of the fee category for the structure or use being replaced, the amount of the fee required shall be the difference between the two fee categories.

SECTION 11.9 MISCELLANEOUS PROVISIONS

- A. Transportation Facility Fees will supplement the fees and condition imposed upon projects pursuant to the provisions of the State Subdivision Map Act, local laws, ordinances, or administrative policies that may authorize the imposition of conditions on, or contributions from, development.
- B. The Director of Transportation will be responsible for administering the provisions of the Transportation Facility Plans.

ARTICLE XII

PRIVATE ROAD STANDARDS

SECTION 12.1 PRIVATE ROAD STANDARDS

In order to promote orderly development, and to provide the proper protection of the public health, safety and general welfare of current and future land owners, and to provide reasonable fire protection, the following minimum standards for private roads are recommended. Private roads are those where the County has no right of way and does not have maintenance responsibilities. As such private roads may have a use by several owners as a means of ingress and egress, and it is considered mandatory that some minimum construction standards be required as conditions of approval where land is divided for building sites on planned developments.

Private roads not constructed to full County public road standards shall not be eligible for acceptance into the County-maintained road system unless they have sufficient right of way and set backs as set forth in the San Bernardino County Standards and Specifications Manual, the General Plan, and the Development Code.

Private roads are permitted only when the local agency finds that the occupants of that particular development will be better served and the welfare of the general public will not be impaired thereby. Normally private road standards are intended to apply only to the following categories of developments and to interior roads only.

- Category I. Private Developments limited to a maximum of two dwelling units per lot;
- Category II. Private Developments with more than two dwelling units per lot;
- Category III. Commercial Developments;
- Category IV. Mobile Home Parks and
- Category V. Recreational Vehicle Parks.

The applicable road standards for each category (or group of categories) are as follows:

SECTION 12.2 PRIVATE DEVELOPMENTS (up to two dwelling units per lot)

Category I

1. Design, roadway widths and construction for private roads shall be in accordance with policies and requirements of San Bernardino County Transportation Flood Control Department and this Manual. Improvement plans shall be prepared by a Registered Civil Engineer and submitted to the Land Development Division and shall be of sufficient detail to provide accurate and full information for roadway design review and inspection. These roads shall be delineated on the site plan and where applicable on the accompanying tentative tract map and/or final development plan.

2. Private road structural sections, road construction and trench backfill shall follow current standards, policies and requirements of the San Bernardino County Transportation Department and this manual.
3. All private road names shall be reviewed and approved by the County Transportation Department's Traffic Division and the road markers shall, unless otherwise approved by County Transportation Department, follow current County standard markers clearly labeled "Private Street".
4. Horizontal design and (vertical) profile design shall conform to the criteria of Article VII and Article VIII respectively of this manual.
5. All private roads shall be designed as loops rather than long cul-de-sacs whenever possible. Generally cul-de-sac lengths should not exceed 600'.
6. Adequate "turn around" facilities per Standard 120 shall be provided for all non-loop streets.
7. Dead end streets shall contain not more than one turn, where possible.
8. Private road typical sections specified on Figure 12-1 Page 12-9 are for County-wide use.
9. Private roads plans and profiles shall be submitted to the Land Development Engineering Division for plan checking. Construction inspection of these roads will be performed by the Transportation Department Public Works under permit.
10. Any proposed entry way textured concrete wide flare driveways, medians, guard gates or other access controls shall be placed outside the public right of way and shall require prior approval of the Land Development Division.

SECTION 12.3 PRIVATE RESIDENTIAL DEVELOPMENTS (more than 2 dwelling units per lot)

Category II

The interior private street/aisle design shall be delineated on the large scale housing site plan and where applicable on the accompanying tentative tract map and/or final development plan and shall reflect the following:

1. Aisles shall be surfaced with asphalt concrete or Portland Cement Concrete of thickness to be determined and certified by a Materials Engineer (minimum of three inches for AC and 4" for PCC).
2. Minimum aisle widths shall be as follows:
24 feet with no parking; 43 feet with single loading, i.e., head in parking one side only; and 62 feet with double loading, i.e. head in parking on both sides. This assumes a parking space 9 feet by 19 feet long. When special sections reserved for compact cars are permitted then 7.5 feet by 15 feet may be used and the above aisle widths correspondingly reduced. Overhangs shall not be permitted. However, a 2.5' minimum additional aisle width for overhang is required where pedestrian walks, landscaping strips, etc., are present. Curbs which serve as wheel stops shall not exceed 4" in height.

Handicapped parking shall be located as close to the building entrance(s) as possible.

3. The first parking stall which is perpendicular to an aisle (or to the first aisle juncture) shall be located a minimum of 40 feet back from the main (public) access road right of way.
4. The interior radius of the main aisle junctures shall be 20 feet minimum. This standard shall also apply to subsidiary aisles unless the applicant, prior to site plan approval, substantiates to the satisfaction of the Land Development Engineer that a lesser standard is acceptable.
5. Turnarounds at dead end aisles shall be required where determined necessary by County Transportation Department and Fire Warden's Office and delineated on the map with appropriate turning radius.
6. Aisle centre line alignment angle points shall require a curve and for the main aisle the minimum aisle centerline curve radii shall not be less than 50 feet. The same standards shall apply to subsidiary aisles.

7. Minimum centerline aisle gradient between intersections shall not exceed 12% or be less than 0.5% between intersections. The maximum grade at any intersection of two aisles or an aisle and a street shall be 6% within the intersection and for at least 50 feet beyond the curb return.
8. Aisles shall intersect with a deviation of no more than 10 degrees from a right angle.
9. Long straight aisles in excess of 350 feet shall not be permitted unless mitigated by curved alignments or if this (in the opinion of Land Development Engineering Division based on satisfactory substantiation proved by the applicant) is not feasible then speed humps shall be required.
10. Private roads will be shown on the grading/site plan and submitted to Land Development Division by the Office of Building and Safety for review and approval.
11. Only approved parkway drainage structures shall be used.
12. Any proposed entry way textured concrete wide flare driveways, medians, guard gates or other access controls shall be placed outside the public right of way and shall require prior approval of the Land Development Division.
13. Construction of private roads and private road related drainage improvements shall be inspected and certified to the Office of the Building and Safety by the applicant's engineer.

SECTION 12.4 COMMERCIAL DEVELOPMENTS

Category III

The interior private street/aisle design shall be delineated on the large scale housing site plan and where applicable on the accompanying tentative map and/or final development plan and shall reflect the following:

1. Aisles shall be surfaced with asphalt/concrete or Portland Cement Concrete of thickness to be determined and certified by a Materials Engineer (minimum of three inches for A.C. and 4" for P.C.).

2. Minimum aisle widths shall be as follows:
24 feet with no parking; 43 feet with single loading, i.e., head in parking one side only; and 62 feet with double loading, i.e. head in parking on both sides. This assumes a parking space 9 feet by 19 feet long. When special sections reserved for compact cars are permitted then 7.5 feet may be used and the above aisle widths correspondingly reduced. A 2.5' minimum additional aisle width is required where overhangs are permitted. Approval for overhangs shall normally be limited to locations where pedestrian walks or landscaping strips are present. Curbs which serve as wheel stops shall not exceed 4" in height.

Handicapped parking shall be located as close to the building entrance(s) as possible.

3. The first parking stall which is perpendicular to an aisle, (or to the first aisle juncture) shall be located a minimum of 40 feet back from the main public access road right of way.
4. The interior radius of the main aisle junctures shall be 20 feet minimum. This standard shall also apply to subsidiary aisles unless the applicant, prior to site plan approval, substantiates to the satisfaction of the Director of Transportation that a lesser standard is acceptable.
5. Turnarounds at dead end aisles shall be required where determined necessary by County Transportation Department and Fire Warden's Office and delineated on the map with appropriate turning radius.
6. Aisle centre line alignment angle points shall require a curve and for the main aisle the minimum aisle centerline curve radii shall not be less than 50 feet. The same standards shall apply to subsidiary aisles unless the applicant prior to site plan approval substantiates to the satisfaction of the Land Development Engineer that a lesser standard is acceptable.
7. Parking lot finished grades shall not exceed 2% or be less than 0.5% unless otherwise approved by the Land Development Engineer.
8. Aisles shall intersect with a deviation of no more than 10 degrees from a right angle.
9. Long straight aisles in excess of 350 feet shall not be permitted unless mitigated by curved alignments or if this (in the opinion of Director of Transportation based on satisfactory substantiation provided by the approval) is not feasible then speed humps shall be required).
- 9A. Large activity centres shall be designed with separate access driveways for trucks. Likewise, the truck circulation system shall be designed to discourage use by automobile traffic.

10. Private roads will be shown on the grading/site plan and submitted to Land Development Division by the Office of Building and Safety for review and approval.
11. Only approved parkway drainage structures shall be used.
12. Any proposed entry way textured concrete wide flare driveways, medians, guard gates or other access controls shall be placed outside the public right of way and shall require prior approval of the Land Development Division.
13. Construction of aisles and related drainage improvements shall be inspected and certified to the Office of the Building and Safety by the applicant's engineer.
14. A separate deceleration and acceleration lane shall be required when determined necessary by the Director of Transportation as directed by Section 6.9, "Criteria for requiring speed change lanes".

SECTION 12.5 MOBILE HOME PARKS

Category IV

Roadways within mobile home parks shall be designed to provide reasonable and convenient traffic circulation and shall be delineated on the site plan and the tentative plan. The roadways shall meet the following standards:

1. No roadway shall be less than thirty-three (33) feet in width if car parking is permitted on one side of the driveway and not less than forty-one (41) feet in width if car parking is permitted on both sides of a roadway.
2. Roadway widths to provide for parking on one side shall be deemed necessary when lots abut the roadway on one (1) side only. Roadway widths to provide for parking both sides shall be deemed necessary when lots abut the roadway on both sides.
3. The entire width of the roadways shall be surfaced with asphalt concrete or Portland Cement Concrete of thickness to be determined and certified by a materials engineer (minimum of three inches AC or minimum of 4" concrete).
4. Any proposed entry way textured concrete wide flare driveways, medians, guard gates or other access controls shall be placed outside the public right of way and shall require prior approval of the Director of Transportation.
6. Private roads will be shown on the grading/site plan and submitted to Land Development Division by the Office of Building & Safety for review and approval.

7. Only approved parkway drainage structures shall be used.
8. Construction of private roads and private road related drainage improvements shall be inspected and certified to the Office of the Building and Safety by the applicant's engineer.

SECTION 12.6 RECREATIONAL VEHICLE PARKS

Category V

1. Engineering and construction for private roads shall be in accordance with current standards, policies and requirements of San Bernardino County and this Manual. These roads shall be delineated on the site plan and where applicable on the accompanying tentative tract map and/or final development plan.
2. Private road typical sections shall conform to Type A on Figure 12-1, Page 12-9. No parking is allowed on the roadway and appropriate signing and curb painting is required as necessary to assure this. Curb and gutters are required only where determined necessary for drainage. The additional width shown outside of pavement on Type A may be waived on one or both sides unless determined necessary for pedestrian safety or convenience.
3. The entire width of the roadways shall be surfaced with asphalt concrete or Portland Cement Concrete of thickness to be determined and certified by a materials engineer (minimum of three inches AC or minimum of 4" concrete).
4. Any proposed entry way textured concrete wide flare driveways, medians, guard gates or other access controls shall be placed outside the public right of way and shall require prior approval of the Director of Transportation.
5. Private roads will be shown on the grading/site plan and submitted to Land Development Engineering Division by the Office of Building and Safety for review and approval.
6. Only approved parkway drainage structures shall be used.
7. Horizontal design and (vertical) profile design shall conform to the criteria of Article VII and Article VIII respectively of this Manual.
8. All private roads shall be designed as loops rather than long cul-de-sacs whenever possible. Generally cul-de-sac lengths should not exceed 600'.

9. Adequate "turn around" facilities per Standard 120 or as approved by the County Fire Warden's Office and the Director of the Transportation Department shall be provided for all non-loop streets.
10. The first parking stall which is perpendicular to an aisle, (or to the first aisle juncture) or the first aisle shall be located a minimum of 40 feet back from the main access road curb.
11. The interior radius of the main aisle junctures shall be 20 feet minimum. This standard shall also apply to subsidiary aisles unless the applicant, prior to site plan approval, substantiates to the satisfaction of the Director of Transportation that a lesser standard is acceptable.
12. Aisle centre line alignment angle points shall require a curve and for the main aisle the minimum aisle centerline curve radii shall not be less than 50 feet. The same standards shall apply to subsidiary aisles unless the applicant prior to site plan approval substantiates to the satisfaction of the Land Development Engineer that a lesser standard is acceptable.
13. Aisles shall intersect with a deviation of no more than 10 degrees from a right angle.
14. Long straight aisles in excess of 350 feet shall not be permitted unless mitigated by curved alignments or if this (in the opinion of Director of Transportation based on satisfactory substantiation provided by the approval) is not feasible then speed bumps shall be required)
15. Construction of private roads and private road related drainage improvements shall be inspected and certified to the Office of the Building and Safety by the applicant's engineer.

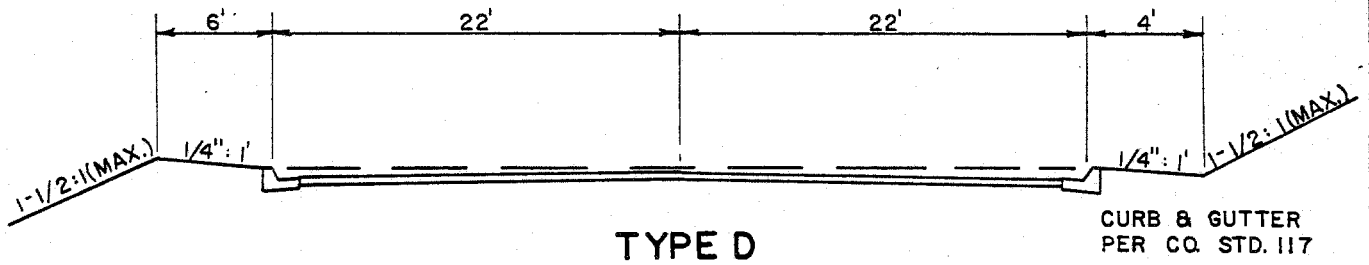
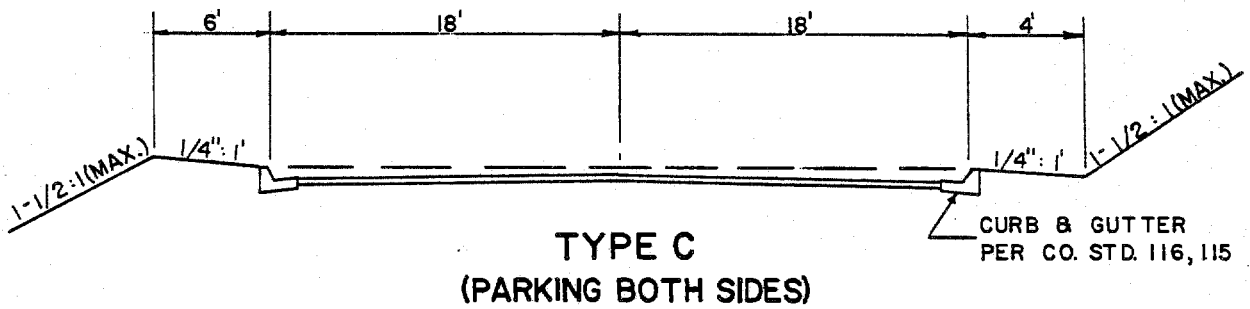
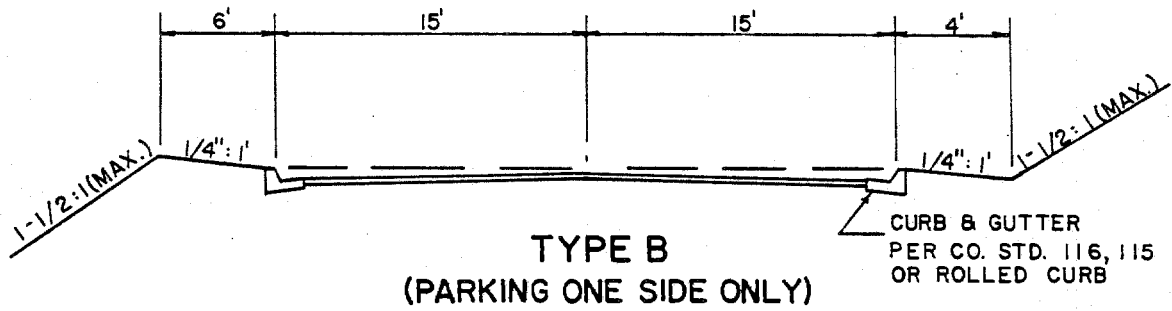
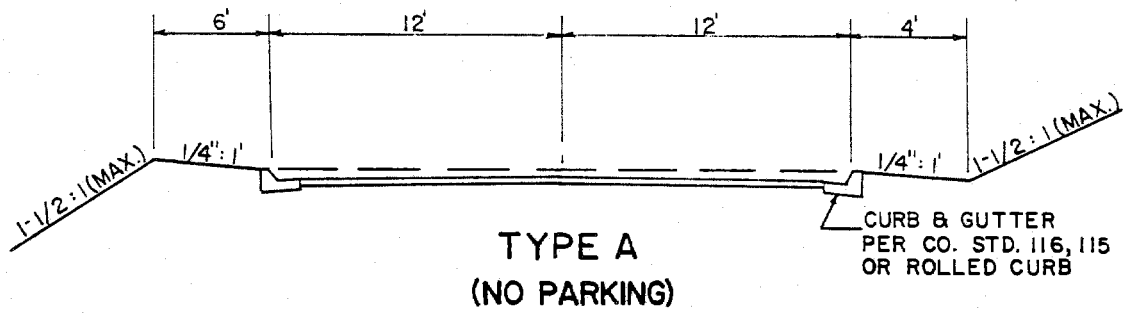

ALTERNATE SECTION MAY BE ALLOWED UPON APPROVAL OF
TRANSPORTATION DEPARTMENT

SAN BERNARDINO COUNTY TRANS. DEPT.		PRIVATE ROAD TYPICAL SECTIONS	FIGURE 12-1
R. Z. 12-91	KEN A. MILLER Director of Transportation		

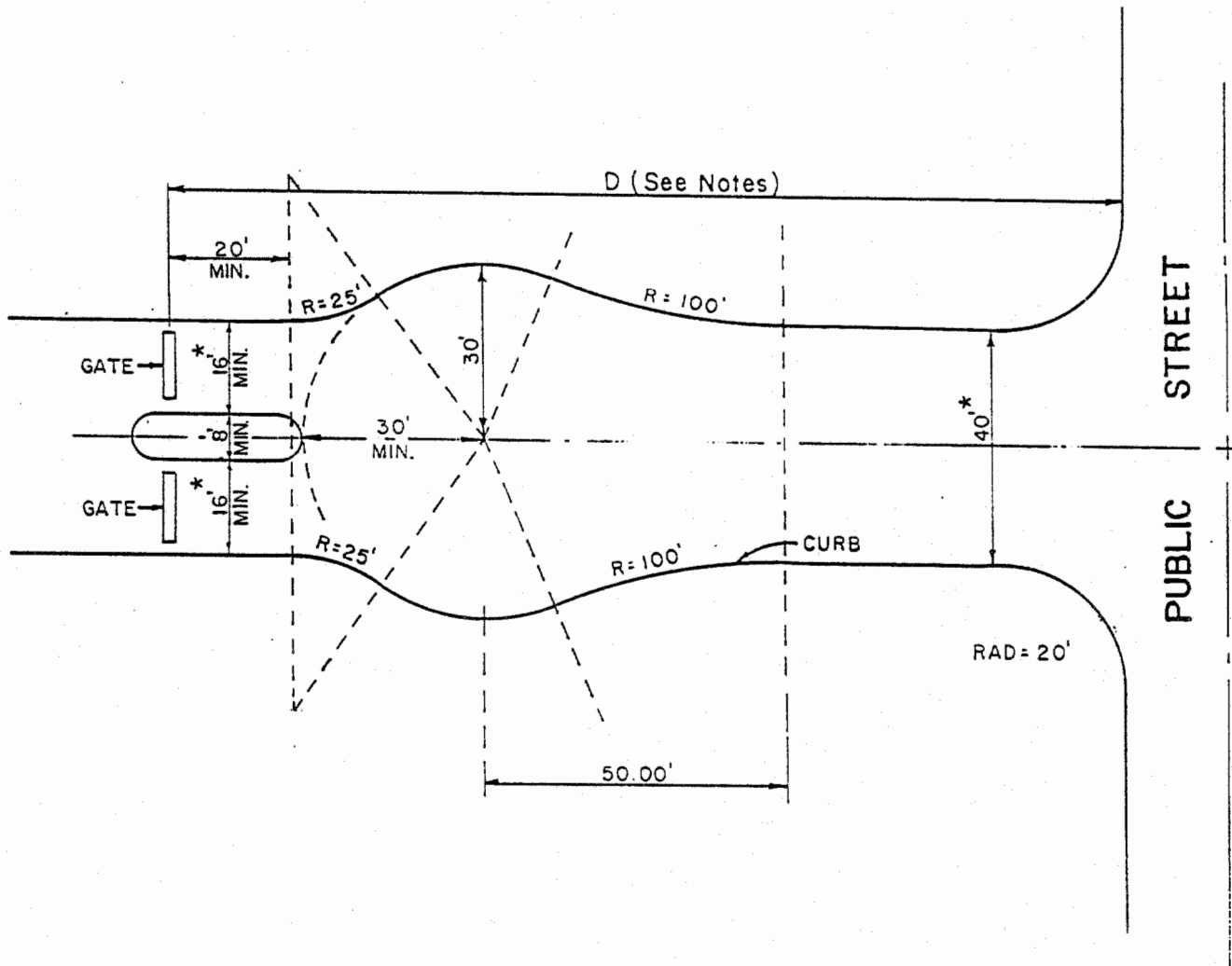

NOTES

1. D = 1' Per Dwelling Unit Served, 100' Minimum
(Multiple lanes may be used to satisfy storage distance requirement.)
 2. Walkways shall be provided on Private Streets as directed by the Director of Transportation.
 3. Curb island optional.
- * The entryway width may be reduced to 26' on Mountain Roads

SAN BERNARDINO COUNTY TRANS. DEPT.		GATED PRIVATE ENTRYWAY	FIGURE 12 - 2
P.I. 91	KEN A. MILLER Director of Transportation		

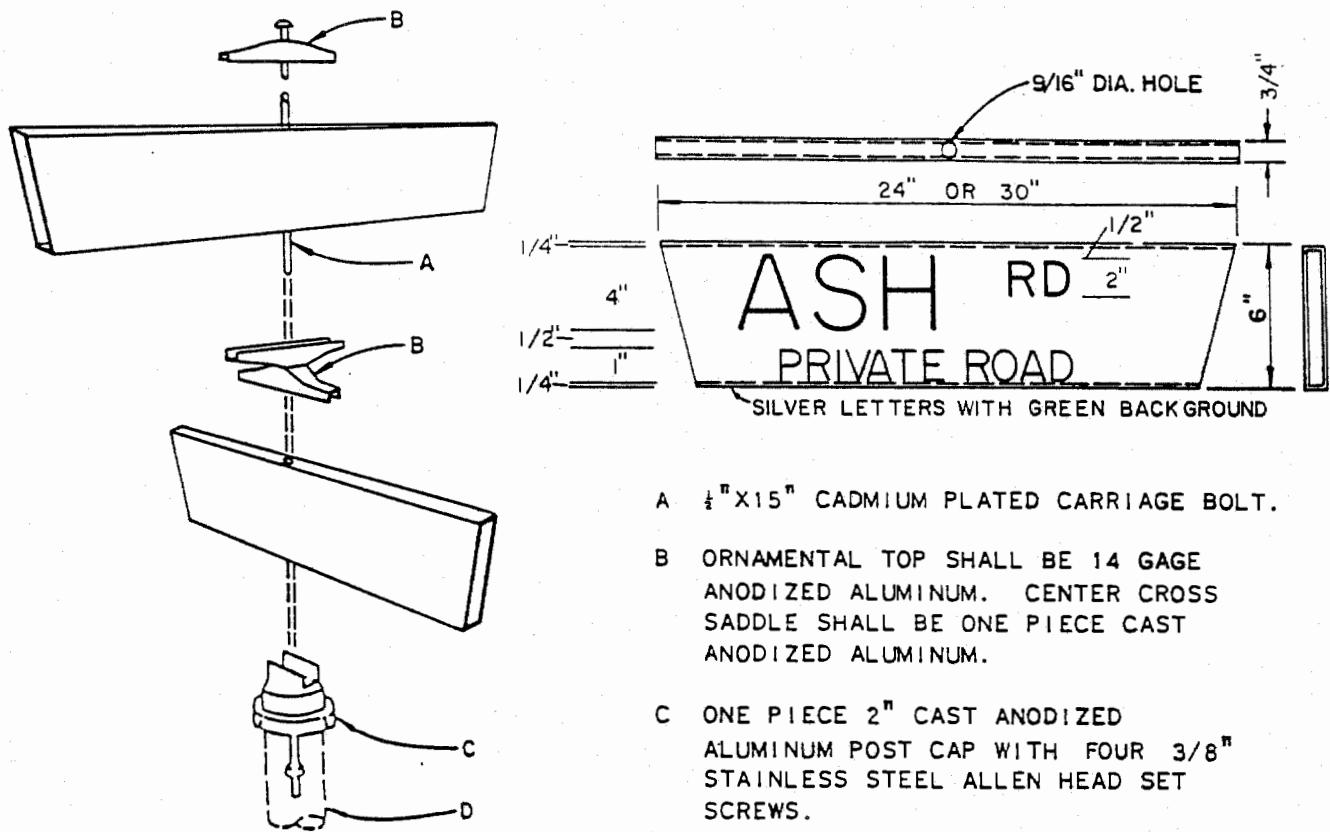

ASSEMBLY

- A $\frac{1}{2}$ " X 15" CADMIUM PLATED CARRIAGE BOLT.
- B ORNAMENTAL TOP SHALL BE 14 GAGE ANODIZED ALUMINUM. CENTER CROSS SADDLE SHALL BE ONE PIECE CAST ANODIZED ALUMINUM.
- C ONE PIECE 2" CAST ANODIZED ALUMINUM POST CAP WITH FOUR $\frac{3}{8}$ " STAINLESS STEEL ALLEN HEAD SET SCREWS.
- D 2" I.D. GALVANIZED PIPE 10' LONG INSTALL SO THAT 2'-6" IS EMBEDDED IN CONCRETE IN THE GROUND, AND 7'-6" REMAINS ABOVE GROUND.

DESIGN: EACH FOUR-WAY UNIT SHALL CONSIST OF TWO DOUBLE FACE SIGNS WITH STREET NAMES MOUNTED AT RIGHT ANGLES WITH CENTER ROD ASSEMBLY.

BRACKET ASSEMBLY: THE POST CAP, ORNAMENT, AND CENTER ROD ASSEMBLY SHALL BE MADE TO MOUNT ON 2" I.D. GALVANIZED PIPE. THE CENTER ROD SHALL BE A $\frac{1}{2}$ " CADMIUM PLATED CARRIAGE BOLT. HEAD OF BOLT SHALL FORM TOP OF ORNAMENT. BOLT SHALL EXTEND THROUGH SIGNS AND FASTEN WITH NUT INSIDE OF POST CAP. POST CAP SHALL BE DEEPLY GROOVED TO SECURELY HOLD SIGN FROM TWISTING AND SHALL BE SECURED TO THE PIPE WITH THREE $\frac{3}{8}$ " STAINLESS STEEL ALLEN HEAD SET SCREWS.

MATERIAL: SIGN SHALL BE GREEN ANODIZED ALUMINUM EXTRUSION OF 6063T-4 ALLOY MATERIAL. ALL ANODIZING SHALL CONFORM WITH ALUMILITE SPECIFICATION #215-R1.

FINISH: SIGN FACES SHALL BE SCOTCHLITE REFLECTIVE SHEETING. THE TRANSPARENT SCREEN PROCESS COLOR SHALL BE AS RECOMMENDED BY THE REFLECTIVE SHEETING MANUFACTURER. APPLICATION OF THE REFLECTIVE SHEETING TO THE SIGN SHALL BE BY METHODS AS APPROVED BY THE REFLECTIVE SHEETING MANUFACTURER.

LETTERING: STREET NAMES SHALL BE 4" HIGH. EACH NAME SHALL BE INDIVIDUALLY LAID OUT TO FIT EITHER THE 24" OR 30" SPACE. THE LETTERS SHALL BE OF THE ROUNDED TYPE STYLE CONFORMING WITH THE STANDARD ALPHABET FOR HIGHWAY SIGNS DESIGNED BY THE U.S. PUBLIC ROADS ADMINISTRATION.

SAN BERNARDINO COUNTY TRANS. DEPT.

DATE: J.E.M. 11-65

R.A.J. 10-81

R.I. 12-91

KEN A MILLER
Director of Transportation

PRIVATE ROAD MARKER

FIGURE

12-3

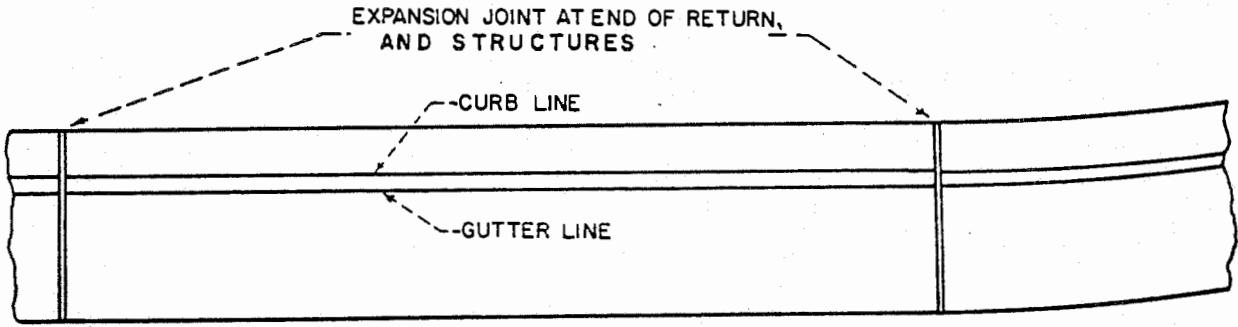

PLAN

0.0495 CUBIC YARDS PER LINEAL FOOT.
20.2 LINEAL FEET PER CUBIC YARD.

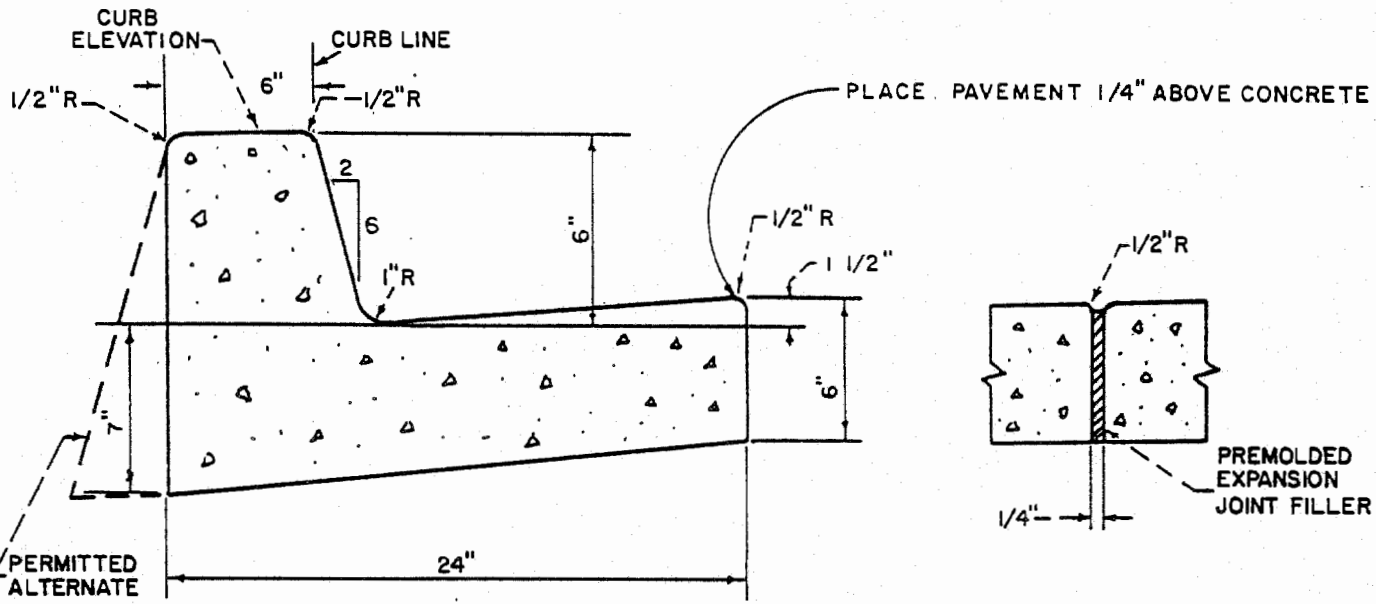

NOTES:

1. 6" CURB SHALL ONLY BE USED ON LOCAL STREETS WHERE DRAINAGE PERMITS.
2. CURB AND GUTTER SHALL BE CONSTRUCTED MONOLITHICALLY OF CLASS "B" CONCRETE.
3. WIDTHS OF STANDARD STREET SECTIONS SHOWN ON PLANS ARE TO CURB LINE UNLESS OTHERWISE INDICATED.
4. WEAKENED PLANE JOINTS SHALL BE CONSTRUCTED AT 10-FOOT INTERVALS, EXCEPT THAT THE INTERVAL SHALL BE VARIED TO ALLOW MATCHING OF JOINTS IN ADJACENT EXISTING IMPROVEMENTS
5. CURING COMPOUND SHALL BE SPRAYED UNIFORMLY ON EXPOSED SURFACES.
6. WHEN CURB AND GUTTER IS PLACED BY AN EXTRUSION MACHINE MINOR FINISHING MAY BE DONE TO PROVIDE AN ACCEPTABLE FINISH AND THE WEAKENED PLANE JOINTS MAY BE SAWCUT.

SAN BERNARDINO COUNTY TRANS. DEPT.		6" CURB AND GUTTER	FIGURE 12-4
APPR 3-75	KEN A. MILLER DIRECTOR OF TRANSPORTATION		
Rev. VEH 2-79 R.I 12-91			